



v45C

45 cm Ku-band
Maritime VSAT Antenna System

Installation & Operation User Guide

Serial number of the product

This serial number will be required for all troubleshooting or service inquiries.

Intellian

© 2021 Intellian Technologies, Inc. All rights reserved. Intellian and the Intellian logo are trademarks of Intellian Technologies, Inc., registered in the U.S. and other countries. The v45C is a trademark of Intellian Technologies, Inc. Intellian may have patents, patent applications, trademarks, copyrights, or other intellectual property rights covering subject matter in this document. Except as expressly provided in any written license agreement from Intellian, the furnishing of this document does not give you any license to these patents, trademarks, copyrights, or other intellectual property. All other logos, trademarks, and registered trademarks are the property of their respective owners. Information in this document is subject to change without notice. Every effort has been made to ensure that the information in this manual is accurate. Intellian is not responsible for printing or clerical errors.

Disclaimer

The information in this user manual is subject to change without prior notice through a product life cycle. A printed version of the user manual is periodically updated and may contain inaccuracies or omissions compared to the recent product information. The most up-to-date information is available on our website at intelliantech.com.

Table of Contents

| | |
|--|----|
| Chapter 1. Precautions | 7 |
| 1.1 Warnings, Cautions, and Notes | 7 |
| 1.2 General Precautions | 7 |
| Chapter 2. Certifications | 8 |
| Chapter 3. Introduction | 11 |
| 3.1 Intellian v45C Introduction | 11 |
| 3.2 Intellian v45C Features | 12 |
| Chapter 4. Planning Installation | 13 |
| 4.1 Selecting Installation Site | 13 |
| 4.1.1 Minimizing Satellite Blockage | 13 |
| 4.1.2 Avoiding RF Interference | 14 |
| 4.1.3 RF Hazard Precautions | 14 |
| 4.2 System Package | 15 |
| 4.2.1 Above Deck Unit (ADU) | 15 |
| 4.2.2 Antenna Control Unit (ACU) | 16 |
| 4.2.3 Packing List | 17 |
| 4.3 System Cables (Customer Supplied) | 18 |
| 4.3.1 Antenna RF Cable (Customer Supplied) | 18 |
| 4.3.2 Gyrocompass Cable (Customer Furnished) | 18 |
| 4.4 Unpacking System Package | 19 |
| Chapter 5. Installing Above Deck Unit (ADU) | 21 |
| 5.1 Antenna Dimensions | 21 |
| 5.2 Antenna Mounting Hole Pattern | 22 |
| 5.3 Designing Mast (Example Only) | 23 |
| 5.4 Routing RF Cable on Mast (Example Only) | 26 |
| 5.5 Connecting RF Cable to Antenna | 27 |
| 5.6 Mounting Antenna on Mast | 29 |
| Chapter 6. Installing Below Deck Unit (BDU) | 30 |
| 6.1 Selecting BDU Installation Site | 30 |
| 6.2 ACU Dimensions | 30 |
| 6.3 Mounting ACU on 19-inch Rack | 31 |

| | |
|--|----|
| 6.4 Antenna System Configuration | 32 |
| 6.4.1 Single Antenna System Configuration | 32 |
| 6.5 ACU Cable Connection | 33 |
| 6.5.1 ACU Back Panel Connectors | 33 |
| 6.5.2 ACU Connector Pinout Guide | 33 |
| 6.5.3 Connecting Power to ACU | 37 |
| 6.5.4 Connecting ACU to Antenna | 37 |
| 6.5.5 Connecting ACU to Modem | 38 |
| 6.5.6 Connecting ACU to Ship Gyrocompass | 39 |
| 6.6 ACU to PC Communication Setup | 40 |
| 6.6.1 TCP/IP Connection | 40 |
| 6.6.2 USB Connection | 40 |
| | |
| Chapter 7. Operating Install Wizard | 41 |
| 7.1 Turning On System | 41 |
| 7.2 Accessing <i>AptusNX</i> | 41 |
| 7.3 Modem Configuration | 42 |
| 7.4 Starting Install Wizard | 44 |
| | |
| Chapter 8. Operating ACU | 53 |
| 8.1 ACU Front Panel View | 53 |
| | |
| Chapter 9. Using <i>AptusNX</i> | 54 |
| 9.1 Introduction | 54 |
| 9.2 Accessing <i>AptusNX</i> for ACU | 54 |
| 9.3 Main Page (Page Login) | 55 |
| 9.4 Top Menus | 56 |
| 9.5 Account Menu | 57 |
| 9.5.1 Account | 58 |
| 9.5.2 Registration | 59 |
| 9.5.3 System | 60 |
| 9.5.4 User Manager | 61 |
| 9.6 Dashboard | 62 |
| 9.6.1 How to Add & Remove Panels (Dashboard Setting) | 62 |
| 9.6.2 How to Arrange Dashboard Layout | 63 |
| 9.6.3 How to Use Shortcut Settings | 64 |
| 9.7 Install Wizard | 64 |
| 9.8 System Tools | 65 |
| 9.8.1 Firmware Upgrade | 65 |

| | |
|--|---------------|
| 9.8.2 iARM Upgrade | 67 |
| 9.8.3 iARM Save & Reboot | 69 |
| 9.8.4 Satellite Library | 70 |
| 9.8.5 Graph | 71 |
| 9.9 System Troubleshooting | 72 |
| 9.9.1 Diagnosis | 72 |
| 9.9.2 Antenna Log | 74 |
| 9.9.3 Antenna Event Log | 75 |
| 9.9.4 Support | 75 |
| 9.10 System Setting | 76 |
| 9.10.1 Ship Setting | 76 |
| 9.10.2 Antenna Setting | 78 |
| 9.10.3 Tracking Satellite Setting | 80 |
| 9.10.4 Network Configuration | 81 |
| 9.10.5 Modem Setting | 83 |
| 9.10.6 SNMP Setting | 86 |
| 9.10.7 Backup & Restore | 87 |
| Chapter 10. Specification | 88 |
| 10.1 Technical Specification | 88 |
| 10.2 Environmental Specification | 90 |
| Chapter 11. Warranty | 91 |
| Chapter 12. Appendix | 92 |
| 12.1 Appendix A. Tightening Torque Specification | 92 |



List of Figures

| | |
|---|----|
| Chapter 4. Planning Installation | 13 |
| Figure 1: Elevation Limit of Obstacles | 13 |
| Figure 2: Potential RF Interference | 14 |
| Figure 3: RF Hazard Precautions | 14 |
| Figure 4: Radome and Pedestal | 15 |
| Figure 5: Front Panel of ACU | 16 |
| Figure 6: Back Panel of ACU | 16 |
| Figure 7: Unpacking System Package | 19 |
| Figure 8: Unpacking BDU Package | 19 |
| Figure 9: Unpacking ADU Package | 20 |
| Chapter 5. Installing Above Deck Unit (ADU) | 21 |
| Figure 10: Antenna Dimensions | 21 |
| Figure 11: Antenna Mounting Hole Template | 22 |
| Figure 12: Recommended Size of Mast | 24 |
| Figure 13: Routing Cable Through Inside of Mast | 26 |
| Figure 14: Installing Sequence of Bolts | 29 |
| Figure 15: Installing Bolts for Antenna-Mast Assembly | 29 |
| Chapter 6. Installing Below Deck Unit (BDU) | 30 |
| Figure 16: ACU Dimensions | 30 |
| Figure 17: 19-inch Rack Mount ACU | 31 |
| Figure 18: Antenna System Configuration | 32 |
| Figure 19: ACU Back Panel Connectors | 33 |
| Figure 20: Connecting Power to ACU | 37 |
| Figure 21: ACU to Antenna Cable Connection | 37 |
| Figure 22: ACU to Modem Cable Connection | 38 |
| Figure 23: ACU to Ship Gyrocompass Cable Connection | 39 |
| Figure 24: NMEA 0183 Gyrocompass Cable Connection | 39 |
| Figure 25: Front Panel Management LAN Port Connection | 40 |
| Figure 26: Front Panel USB Port Connection | 40 |
| Chapter 7. Operating Install Wizard | 41 |
| Figure 27: Front Panel Management LAN Port Connection | 41 |
| Chapter 8. Operating ACU | 53 |
| Figure 28: ACU Front Panel View | 53 |

Chapter 1. Precautions





1.1 Warnings, Cautions, and Notes

WARNING, CAUTION, and NOTE statements are used throughout this manual to emphasize important and critical information. You must read these statements to help ensure safety and to prevent product damage. The statements are defined below.

| | |
|---|--|
|  | <p>WARNING</p> <p>WARNING indicates a potentially hazardous situation which, if not avoided, could result in death or serious injury.</p> |
|  | <p>CAUTION</p> <p>CAUTION indicates a potentially hazardous situation which, if not avoided, could result in minor or moderate injury. It may also be used to alert against unsafe practices.</p> |
|  | <p>NOTE</p> <p>A NOTE statement is used to notify people of installation, operation, programming, or maintenance information that is important, but not hazard-related.</p> |

1.2 General Precautions

Before you use the antenna, make sure that you have read and understood all safety requirements.

| | |
|---|--|
|  | <p>THIS WAY UP</p> <ul style="list-style-type: none"> Place the boxes/crates on the floor with the arrow pointing up. |
|  | <p>FRAGILE</p> <ul style="list-style-type: none"> Since the Radome is fragile, handle it with care. Do not apply excessive pressure or shock. These may cause surface cracking or other damage. |
|  | <p>DO NOT STACK</p> <ul style="list-style-type: none"> Do not stack boxes/crates as there is a risk boxes/crates may fall and be damaged. |
|  | <p>KEEP DRY</p> <ul style="list-style-type: none"> Always make sure the antenna is stored on a dry surface in a dry, well-ventilated area. The antenna is designed to withstand a normal rain shower; however, water resistance cannot be guaranteed if the antenna is submerged. |

* **DO NOT SHIP VIA RAIL:** Ensure not to ship any system via Rail.

* **DO NOT STORE THE ANTENNA WRAPPED IN A TARP, TENT, VINYL, AND OTHERS:**

To avoid damage to radome paint, do not use a cover on the radome. Using any type of cover may cause paint damage. Intellian radomes are designed to withstand exposure to rain, humidity, and sun/UV rays when assembled according to Intellian instructions, and when the supplied approved hardware and sealants are used. Under no circumstances should an Intellian radome be covered by any protective covering that adheres, bonds, or clings to the surface, whether by self-adhesion or tension.

Chapter 2. Certifications

FCC Part 15 Subpart B Declaration of Conformity

We, Intellian Technologies, Inc. located at 18-7, Jinwisandan-ro, Jinwi-myeon (Chungho-ri), Pyeongtaek-si, Gyeonggi-do 17709 Korea declare under our sole responsibility that the product(s) described in the below to which this declaration relates is in conformity with the requirement of the FCC Part 15 Subpart B.

Product Information:

| | |
|----------------------|---|
| Product Name: | Intellian v45C, 45cm Ku-band Maritime Stabilized Antenna System |
|----------------------|---|

Test Result:

| Standard | Test | Rule Section | Test Report Number | Result |
|-----------------------|--------------------------------|--|--------------------|--------|
| FCC Part 15 Subpart B | Conducted Disturbance | ANSI C63.4 : 2014 FCC part 15 Subpart B | DREKFCC2101-0012 | Pass |
| | Radiation emissions below 1GHz | ANSI C63.4 : 2014 FCC part 15 Subpart B | DREKFCC2101-0012 | Pass |

Supplementary Information:

| | |
|---|---|
| Notified Body Involved: (Testing Organization) | DT&C Co., Ltd. 42 Yurim-ro, 154beon-gil, Cheoin-gu, Yongin-si, Gyeonggi-do, Korea 17042 |
| Technical/Compliance File Held by: | Intellian Technologies, Inc. 18-7, Jinwisandan-ro, Jinwi-myeon (Chungho-ri), Pyeongtaek-si, Gyeonggi-do 17709 Korea |
| Place and Date of Issue: | Gyeonggi-do, Korea on January 12, 2021 |

Authority: **Kevin Eom**
 / CTO, R&D

Signature: _____

Date: _____ **12th January, 2021**

Intellian Technologies, Inc.
US Headquarters
9004 Research Dr.
Irvine, CA 92618 USA
Tel: +1 949 727 4498

Intellian Technologies, Inc.
EMEA & APAC Headquarters
348-5 Chungho-Ri, Jinwi-Myeon
Pyeongtaek-Si, Gyeonggi-Do, 451-862 Korea
Tel: + 82 31 379 1000

Doc Number IT21-DC0112-01

FCC Declaration of Conformity

Intellian Technologies, manufactures of stabilized maritime VSAT antenna systems for satellite communication at sea, supplies stabilized maritime VSAT antenna systems to the satellite communication service providers for their ESV (Earth Station on Vessels) networks.

FCC §25.218 defines the provisions for blanket licensing of ESV antennas operation in the Ku-band. It defines the antennas radiation, and each article regulates the followings;

- §25.218 (f)(1): Regulation for Azimuth Direction & Co Polarization
- §25.218 (f)(2): Regulation for Other Direction & Co Polarization
- §25.218 (f)(3): Regulation for Cross Polarization

Intellian Technologies, Inc. declares that v45C complies with the threshold level as defined in §25.218(f)(1);, and declares that v45C is in accordance with all defined regulations from §25.218(f)(2) to §25.218(f)(3) at the below stated input power spectral density, with an N value of 1.

| | |
|-----------------------------|---|
| Product description | Intellian v45C, 45cm Ku-band maritime VSAT antenna system |
| EIRP spectral density limit | -21.77 dBW/ 4KHz |

Intellian Technologies, Inc. declares that the above antennas will automatically cease the transmission with a mute command to the modem within 100 milliseconds if the target satellite and the axis of the main lobe of the ESV antenna exceeds 0.5 degree and will not resume until such angle is less than or equal to 0.2 degree in accordance with the requirements of §25.228 (b) and §25.228 (c).

;-

Radiation pattern data is available upon request to verify the conformance.

Authority: Kevin Eom
/ CTO, R&D



Signature: _____



Date: February 05, 2021

Intellian Technologies, Inc.
US Headquarters
11 Studebaker
Irvine, CA 92618 USA
Tel: +1 949 727 4498

Intellian Technologies, Inc.
EMEA & APAC Headquarters
5F IDIS Tower, 344, Pangyo-ro (Sampyeong-dong),
Bundang-gu, Seongnam-si, Gyeonggi-do 13493 Korea
Tel: +82 2 511 2244

RED Declaration of Conformity (DoC)

We, Intellian Technologies, Inc. located at 18-7, Jinwisandan-ro, Jinwi-myeon, Pyeongtaek-si, Gyeonggi-do 17709, Korea declare under our sole responsibility that the product(s) described in the below to which this declaration relates is in conformity with the *essential requirements* and *other relevant requirements* of the Radio Equipment Directive (2014/53/EU).

Product Information:

| | |
|-------------------------|---|
| Product Name(s): | Intellian v45C, 45cm Ku-band maritime VSAT Antenna System |
|-------------------------|---|

To provide the presumption of conformity in accordance to Annex III(encompassing Annex II) of Directive 2014/53/EU; the following harmonized standards and normative documents are those to which the product’s conformance is declared, and by specific reference to the essential requirements of Article 3 of the Directive 2014/53/EU.

| 2014/53/EU Article | Standard(s) Applied in Full | Result |
|---------------------|-----------------------------|--------|
| SAFETY (Art 3.1.a) | EN 62368-1:2020 +A11:2020 | Pass |
| EMC (Art. 3.1.b) | EN 301 843-1 v2.2.1 | Pass |
| SPECRTUM (Art. 3.2) | EN 302-340 v2.1.1 | Pass |

Supplementary Information:

| | |
|---|--|
| Notified Body Involved: (Testing Organization) | DT&C Co., Ltd. 42, Yurim-ro, 154 beon-gil, Cheoin-gu, Yongin-si, Gyeonggi-do 17042, Korea |
| Technical/Compliance File Held by: | Intellian Technologies, Inc. 18-7, Jinwisandan-ro, Jinwi-myeon, Pyeongtaek-di, Gyeonggi-do 17709, Korea |
| Place and Date of issue: | Gyeonggi-do, Korea on 11 March, 2021 |

Authority: **Kevin Eom**
 / **CTO, R&D**

Signature: _____ 

Date: _____ **March.12. 2021**

Intellian Technologies USA, Inc.
US Headquarters
11 Studebaker
Irvine, CA 92618 USA
Tel: +1 949 727 4498

Intellian Technologies, Inc.
EMEA & APAC Headquarters 5F IDIS Tower,
344, Pangyo-ro (Sampyeong-dong), Bundang-gu,
Seongnam-si, Gyeonggi-do 13493 Korea
Tel: +82 2 511 2244

Doc Number IT21-DC0312-01

Chapter 3. Introduction

3.1 Intellian v45C Introduction

Intellian v45C is a Ku-band stabilized VSAT maritime antenna system. The v45C provides VSAT solutions for efficient performance with a compact and lightweight mechanical design.

Intellian v45C's RF design is optimized for the highest and stronger Ku band performance among compact VSAT, minimizing possible performance loss during satellite communication. The compact 45cm reflector and 6 Watt BUC and Universal LNB are sufficient to provide optimal communication. Intellian v45C provides high-speed communication on both HTS(High-throughput Satellite) and wide beam Ku-band satellites coverage network.

The v45C includes a single cable, combining Tx, Rx, and DC power into one single solution. This allows for a faster and more cost-effective installation, as well as easier troubleshooting and maintenance. The single coaxial cable is connected externally on the base of the radome with no requirement to access the inside of the radome, reducing complexity for the user.

3.2 Intellian v45C Features

COMPACT AND LIGHT VSAT

Intellian's v45C is a compact and light-weight 45cm and 23kg maritime Ku-Band system. The v45C VSAT system is designed to deliver enhanced connectivity and user experience to smaller boats and vessels, including fishing, leisure, commercial, and government. The antenna offers exceptional value and performance no matter the communication needs or space constraints onboard.

QUICK & EASY INSTALLATION

The system is designed to be easy to install and reduce costs for users. The v45C includes a single cable design, combining Tx, Rx, and DC power into one single solution. The single coaxial cable is connected externally on the base of the radome with no requirement to access the inside of the radome, reducing complexity for the customer during installation and maintenance.

OPTIMIZED PERFORMANCE

Customers have the flexibility of connecting their v45C antenna via their Ku-band service provider of choice, knowing that the RF design is optimized to deliver best-in-class performance and efficiency. The advanced design ensures optimal performance on both HTS and wide beam Ku-band satellites, delivering an unparalleled user experience for a product of this form factor.

ANTENNA MANAGEMENT PLATFORM

AptusNX is a responsive web user interface to manage and control the antenna system. AptusNX includes an intelligent installation Wizard to simplify system configuration so that users can become connected faster than ever before. The platform also includes a diagnosis function that enables accurate and enhanced antenna performance checks both on-board and remotely. This reduces the need for on-board maintenance and improves performance.

UNRIVALLED GLOBAL SUPPORT

Intellian's global operation and logistic centers ensure the fastest, most cost-effective delivery of products and support services to our customers. Intellian is able to provide industry-leading global support through our in-house engineers and an extensive network of dealers and service partners. Intellian v45C users can feel secure in the knowledge that wherever the voyage takes them, a highly trained, fully equipped Intellian support facility is nearby.

Chapter 4. Planning Installation

The antenna installation requires extreme precaution and safety measures given its size and weight. Failure to follow the correct installation process may lead to injury of the installer and/or cause damage to the system. In order to maximize the performance of the system, a thorough review of this installation guide is strongly recommended, as well as executing the installation process as it is noted in this manual.

4.1 Selecting Installation Site

The system should be placed in an area onboard the vessel with little to no RF signal blockage. When the antenna is transmitting, obstacles in way of the beam path will cause decreased satellite signal strength. The antenna unit should have direct line-of-sight with the desired satellite without any obstacles in the beam path. Certain minimum distances between the antenna and other onboard devices must also be considered during installation.

4.1.1 Minimizing Satellite Blockage

Install the antenna in accordance with the following procedures to ensure maximum performance of the antenna. The ideal antenna site should have a clear view of the horizon or satellite with all around clearance. Make sure there are no obstacles within the EL range -5° to $+115^{\circ}$ from the center of the antenna. Obstacles can interrupt the satellite signal transmission and reception of the antenna.

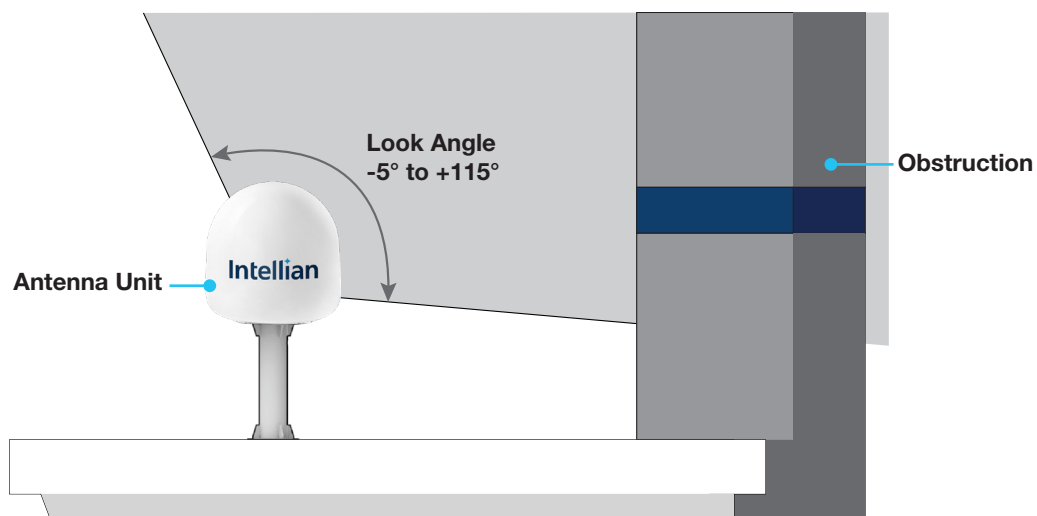

Figure 1: Elevation Limit of Obstacles

4.1.2 Avoiding RF Interference

Do not install the antenna near the high power shortwave radar. Most radar transmitters emit RF energy within an elevation range of -15° to $+15^{\circ}$. For this reason, it is recommended to position the antenna at least 4.6 m (15.09 feet) away from the radar.

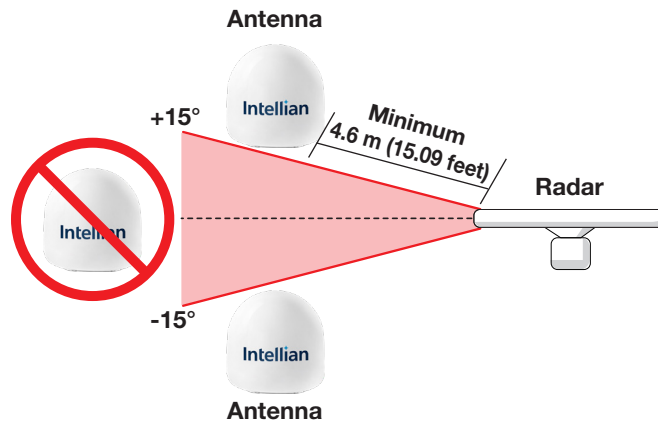

Figure 2: Potential RF Interference

4.1.3 RF Hazard Precautions

The antenna is designed to be used with radiation transmitting equipment manufactured by others. Exposure to RF radiation, including exposure associated with an improper use of the transmit equipment, may be hazardous to persons close to the above deck unit. Ensure the safety of personnel who work on the system.

During transmission, ensure to keep the minimum safety distance. The recommended minimum safety distance to the reflector on the focal line is about 12 m (39.37 ft), based on a radiation level of 1 mW/cm² that applies under uncontrolled environment. No hazard exists $>20^{\circ}$ below the antenna's mounting plane.

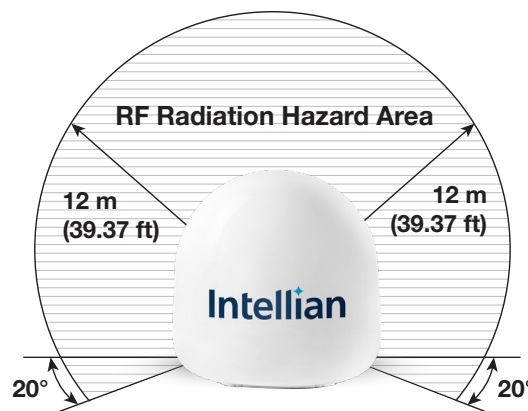

Figure 3: RF Hazard Precautions

4.2 System Package

4.2.1 Above Deck Unit (ADU)

The ADU includes an antenna pedestal inside a radome assembly unit. The pedestal consists of a satellite antenna main dish with RF components mounted on a stabilized pedestal. The radome protects the antenna pedestal assembly unit from the severe marine environment.



Figure 4: Radome and Pedestal

4.2.2 Antenna Control Unit (ACU)

Antenna Control Unit (ACU) controls Antenna system operation. The following functions are supported by ACU.

- Power supply to antenna
- Status indication through LED indicator
- Antenna management and control support
- Support for Interface with various types of modems
- Quick and easy installation through Installation Wizard
- Support OpenAMIP protocol
- NMEA 0183 Gyrocompass Connection
- Enhanced Auto & Self Diagnosis
- AptusNX Web application



Figure 5: Front Panel of ACU

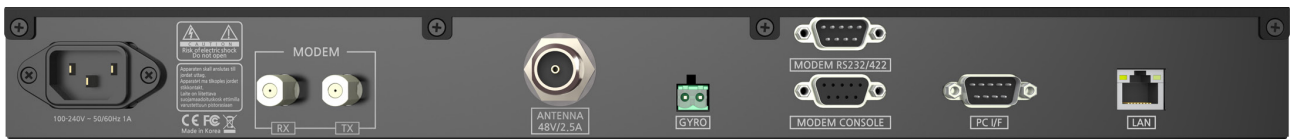

Figure 6: Back Panel of ACU

4.2.3 Packing List

Before beginning installation, make sure you have all the included components.

| ADU Package | | | |
|--------------------------------|-------------|---------------------------|---|
| Item | Q'ty | Size | Description |
| Above Deck Unit (ADU) | 1 | | Radome and Pedestal |
| BDU Package | | | |
| Item | Q'ty | Size | Description |
| Antenna Control Unit (ACU) | 1 | 431 mm x 350 mm x 44.3 mm | Antenna Control Unit (ACU) |
| Quick Installation Guide (QIG) | 1 | | Installation guide |
| RF Hazard Sticker | 1 | | Radiation safety distance (12 m) label |
| Mounting Template | 1 | | Real size drawing of antenna mounting hole pattern |
| ACU Rack Mount Bracket | 2 | | For installing ACU to 19-inch rack |
| Flat Head Screw | 10 | M4 x 12L | For mounting ACU Rack Mount Bracket on ACU |
| AC Power Cord (CEEE7/7) | 1 | 1.5 m | ACU power cord (220 V) |
| Ethernet Cable (RJ45 to RJ45) | 1 | 1 m | To connect ACU to PC / network device |
| RF Cable (F (M) to F (M)) | 2 | 1 m | To connect ACU to Modem (Tx / Rx) |
| Hex Bolt (BUMAX) | 5 | M8 x 40L | Bolt kit for antenna-deck (mast) assembly (1 spare set included) |
| Flat Washer (BUMAX) | 5 | M8 | |
| Spring Washer (BUMAX) | 5 | M8 | |

4.3 System Cables (Customer Supplied)

4.3.1 Antenna RF Cable (Customer Supplied)

Due to the signal loss across the length of RF coaxial cable on L-Band, Intellian recommends to build RF cables using the following 50 Ω coaxial cable types for standard system installation. If you need RF cables that run longer than the maximum cable length recommended, contact Intellian Technical Support for assistance.

- **Cable Requirements**

| Coaxial Cable Type | Connector | Max. DC Resistance | Attenuation @ 2 GHz | Max. Cable Length (\leq 16 dB loss @ 2 GHz) |
|--------------------|----------------|--------------------|---------------------|---|
| LMR400 | N (M) to N (M) | 0.8 Ω | 0.196 dB/m | 60 m |
| LMR600 | | | 0.128 dB/m | 100 m |

Note:

- Optimal tightening torque for N type RF connector: 1.5 N-m
- Maximum RF loss at 2 GHz: 16 dB including connectors

4.3.2 Gyrocompass Cable (Customer Furnished)

General types of gyrocompass cables are recommended for the compatible connection to Intellian antennas which are used in various environments of vessels.

| Standard | NMEA 0183 |
|---------------------|---|
| Connector Type | 2 pin terminal block connector |
| Cable Type | 2-wire cable with one enclosed shield cable |
| Heading Information | Supports $\$$ HEHDT, baud rate 4800, format 8N1 as standard |

4.4 Unpacking System Package

Follow the steps for easy and safe unpacking. The system package consists of two sub-packages that an ADU Package and a BDU Package.

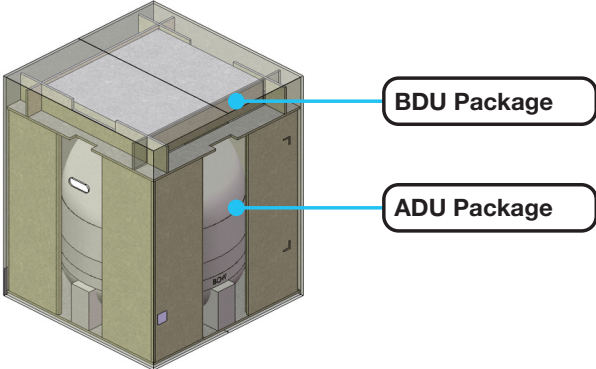

Figure 7: Unpacking System Package

- 1. Remove the top cover and take out the BDU package.

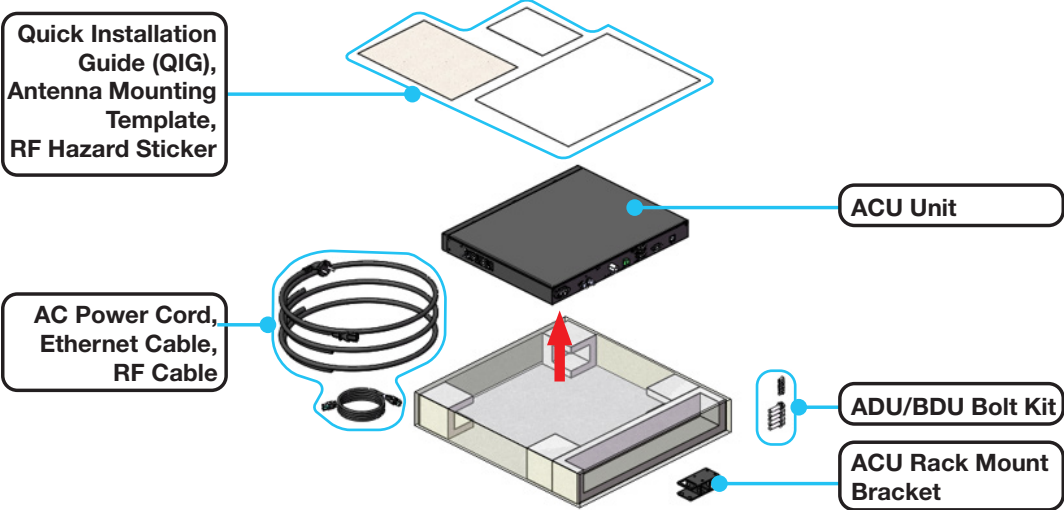

Figure 8: Unpacking BDU Package

2. Take out the ADU package.

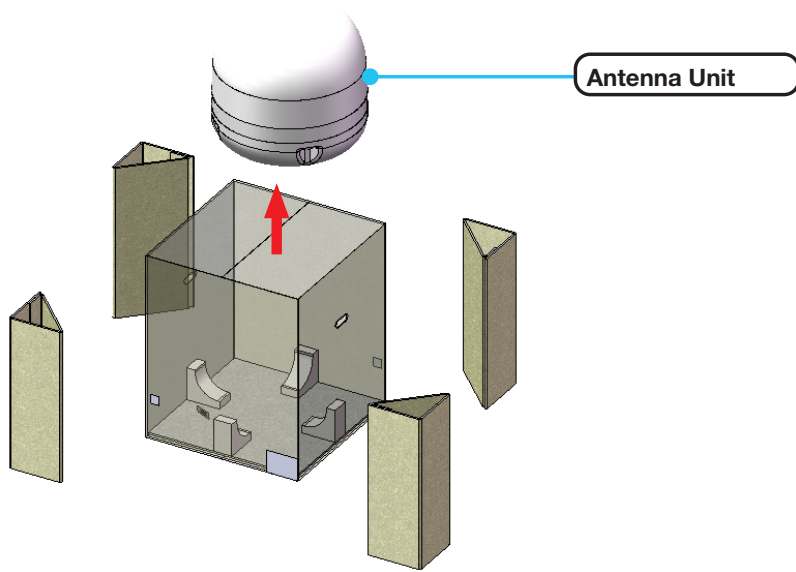

Figure 9: Unpacking ADU Package

Chapter 5. Installing Above Deck Unit (ADU)

5.1 Antenna Dimensions

Confirm the height and diameter of the antenna unit shown in the following figure before installing it. To protect the cable connectors on the bottom of radome, the antenna is shipped from the factory with protective rubber cap on the RF port.

Unit: mm (inch)

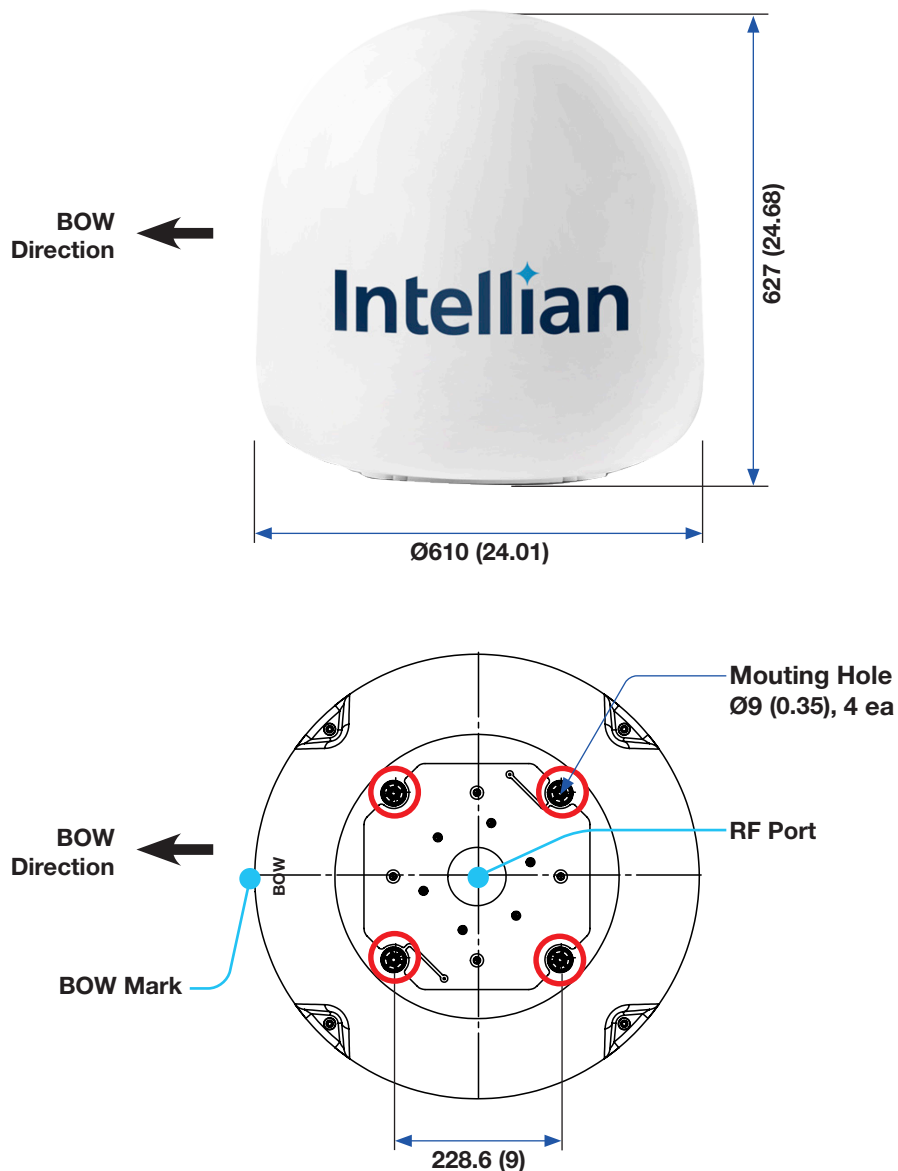

Figure 10: Antenna Dimensions



NOTE

Position the antenna with the BOW direction parallel to the center line of the ship.

5.2 Antenna Mounting Hole Pattern

Use the supplied mounting template when drilling mounting holes on the mast. The hole placement for the antenna must match the mounting hole pattern on the template.

Make a cut-out of a cable hole in the center of the template using the 'Cutting Hole for Cable Hole' pattern to install a cable. Make drill holes using the 'Drill Holes' pattern to mount the antenna.



WARNING

When reusing an existing mast, check the condition of holes on the mast and make sure those are proper to use compared to the hole locations and sizes printed on the mounting template.

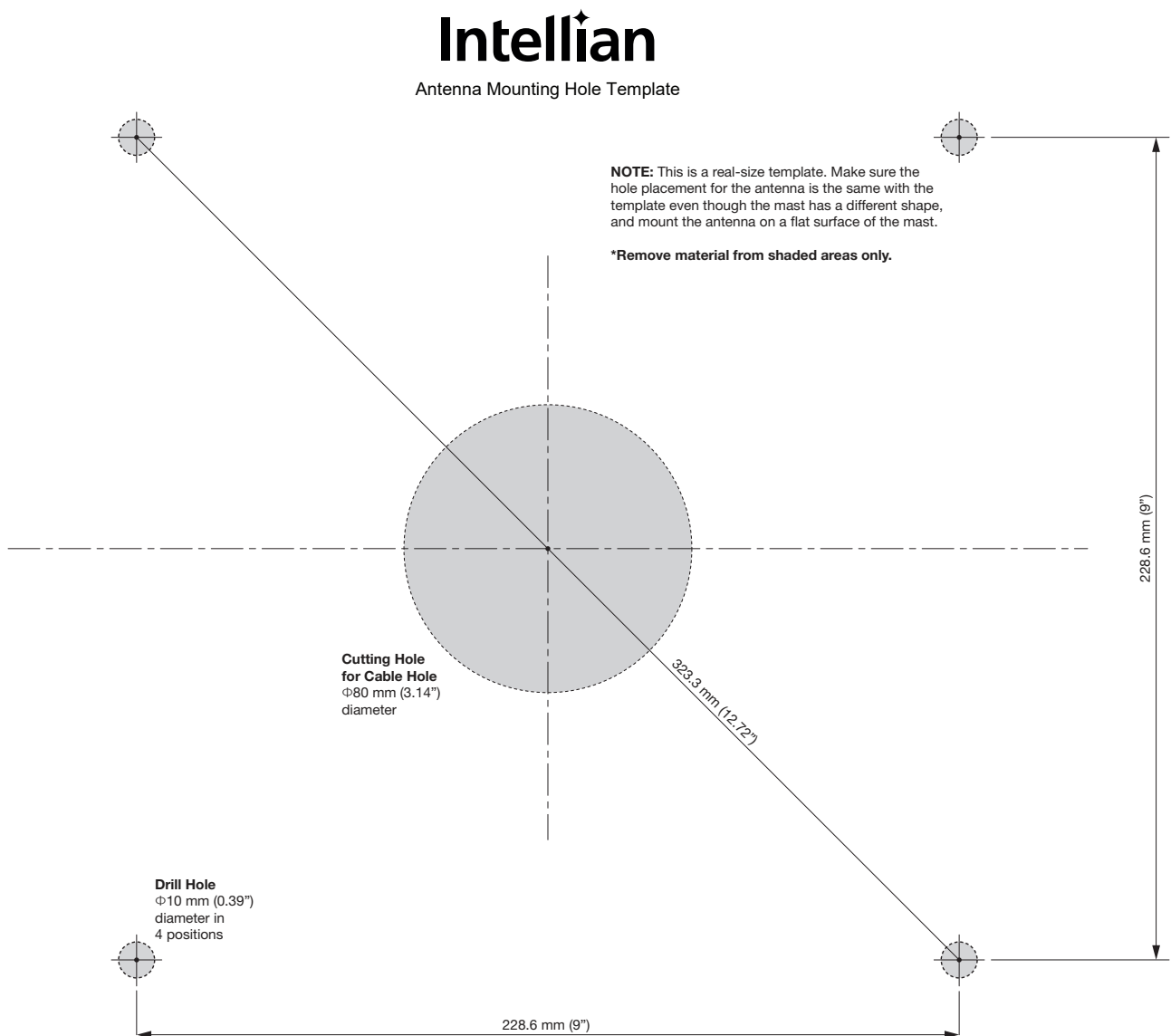

Figure 11: Antenna Mounting Hole Template

5.3 Designing Mast (Example Only)

The installation mast must be robust enough to prevent flex, vibration, and sway when an external force is exerted on the mast with antenna and radome. Refer to the following mast drawings for more details.



NOTE

This is a general example of routing cables on the mast. The routing method is may differ depending on the ship's environment.

WARNING



The recommended thickness of the mast plate is 10 mm. The minimum thickness of the mast plate must be 5 mm. If the thickness of the mast plate is different from the recommended size, choose right sized bolts for mounting the antenna on the mast according to the table below. The quality of bolts must be equal to or better than supplied bolts by Intellian (Recommend using the same brand bolt).

| Mast Plate Thickness | Recommended Bolt Size |
|-------------------------|-----------------------|
| 5 ~ 10 mm (Recommended) | M8 x 40L (Supplied) |
| 8 ~ 15 mm | M8 x 45L |
| 13 ~ 20 mm | M8 x 50L |
| 18 ~ 25 mm | M8 x 55L |
| 23 ~ 30 mm | M8 x 60L |

To use the supplied bolts (M8 x 40L) for mounting the antenna on a mast, Intellian recommends designing the mast plate thickness is 10 mm.

- A** If the bolt length is longer than M8 x 40L, the bolt thread stick-out protruding beyond the nut inside the radome can damage parts of the antenna.
- B** If the bolt length is shorter than M8 x 40L, the supplied antenna-mast mounting bolts can be too short to mount the antenna on the mast securely.

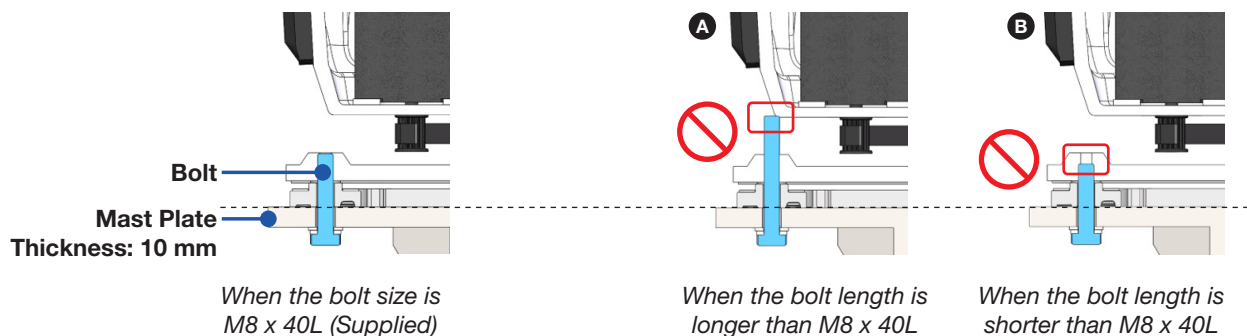

Unit: mm (inch)

Unit: mm (inch)

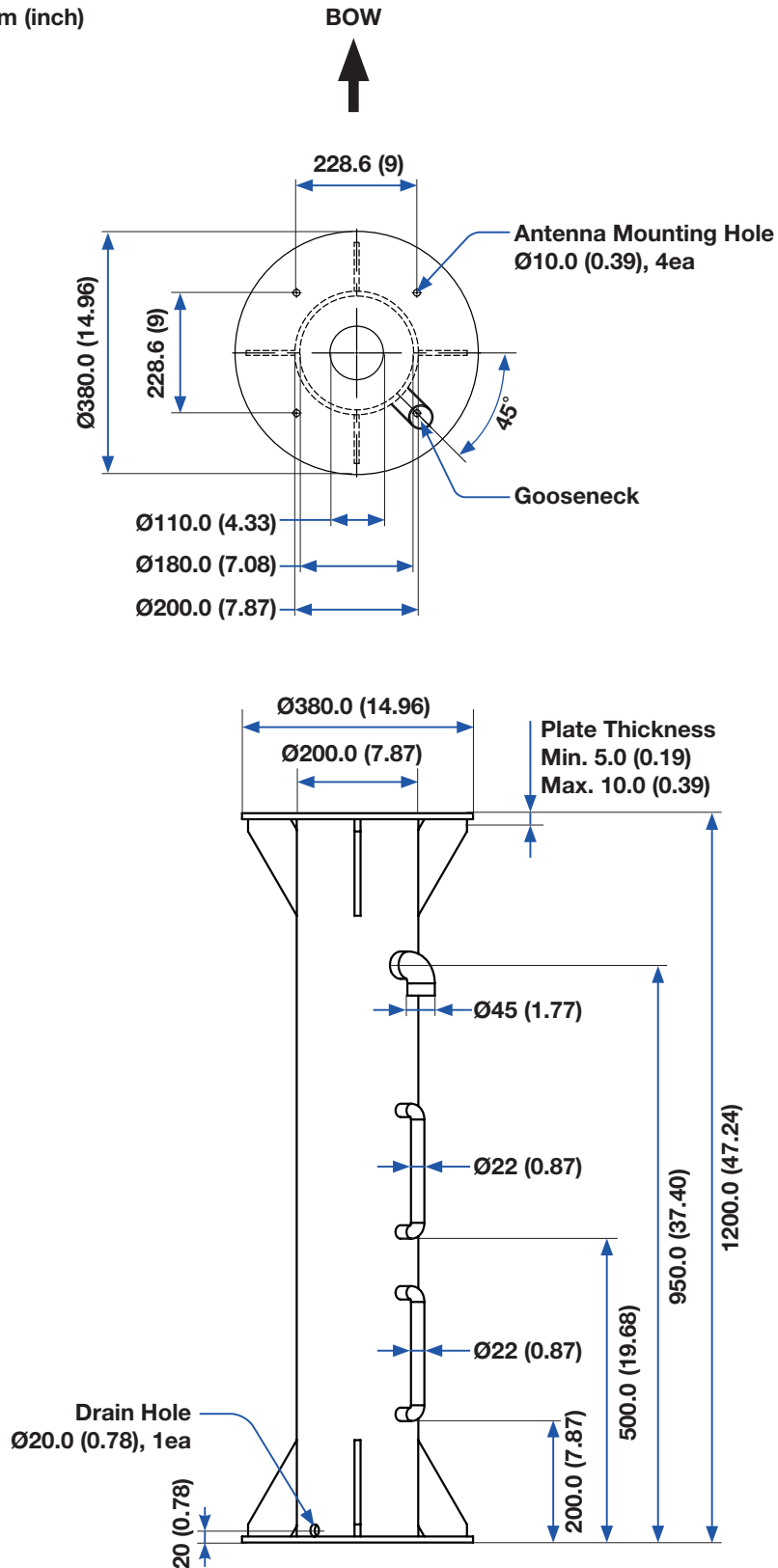
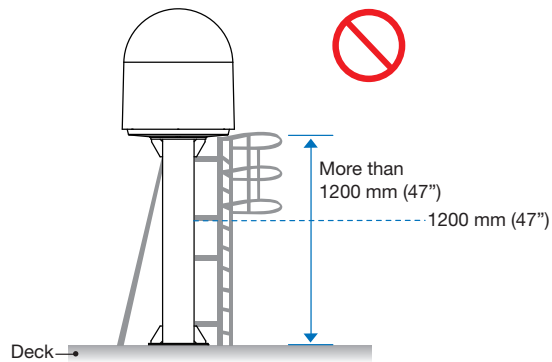
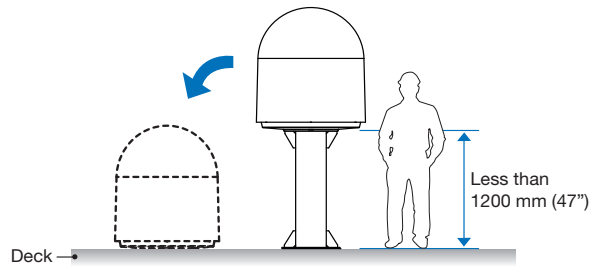

Figure 12: Recommended Size of Mast

WARNING



Intellian strongly recommends installing the antenna less than 1200 mm (47") above the deck for safe access and maintenance. When installing the antenna more than 1200 mm (47") above the deck, make sure to have enough working space around the mast where the installer can move around and put the radome down.



5.4 Routing RF Cable on Mast (Example Only)

The cable must be routed from the antenna and through various areas of the ship to end up at the antenna control unit. When pulling the cables in place, avoid sharp bends, kinking, and excessive force. After placement, seal the deck penetration gland and tie the cable securely in place. The cable bracket must be installed on the mast to fix the relevant cable. The gooseneck must be installed on the side of the mast to protect the relevant cable against water.



WARNING

Ensure that cable has been run through watertight fittings to prevent water entry into the vessel when installation is completed.



NOTE

This is a general example of routing cables on the mast. The routing method is may differ depending on the ship's environment.

Routing Cable Through Inside Mast

1. Before placing the radome on the mast, route the cable through the gooseneck on the deck and the built-in gooseneck on the mast for easier placing of the RF Cable through the inside of the mast as shown in the picture.
2. Maintain a sufficient cable length (at least 2 m) when routing the cable on the surface and inside of the mast. After connecting the cable to the connector on the radome, adjust the length and fix the cable on the cable brackets using cable ties.

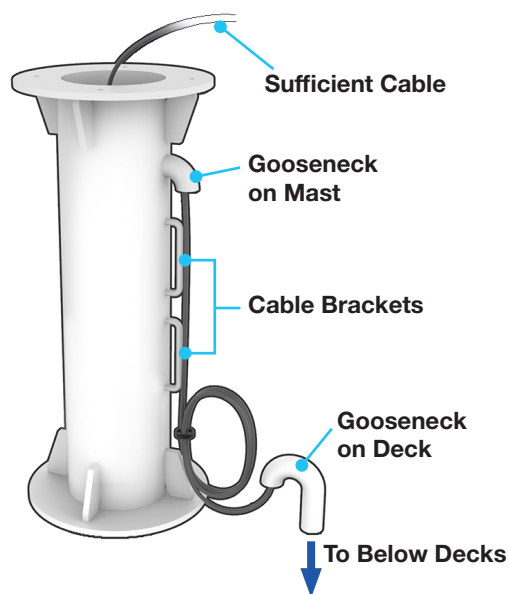

Figure 13: Routing Cable Through Inside of Mast



CAUTION

Do not leave the cables on the top surface of the mast. When putting down the antenna on the mast, there is a risk of damage to the cable connector if the cable is located on the top surface of the mast.

5.5 Connecting RF Cable to Antenna

1. Terminate N(M) connector on the end of the RF Cable. Intellian recommends using a genuine cable connector and tools. Refer to the cable termination instructions provided by the manufacturer to terminate the N connector.
2. Lift the antenna above the mast using hands and carefully lower down the antenna toward the mast. Maintain sufficient space (at least 150 mm) between the bottom of radome and the mast for cabling work.

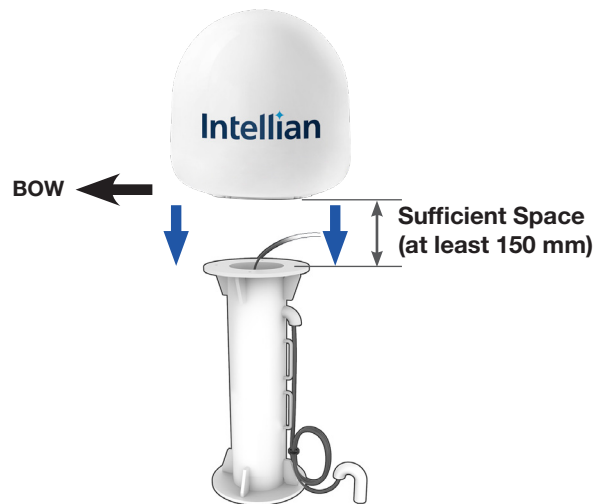

NOTE

Position the antenna with the BOW direction parallel to the center line of the ship.

3. Remove the rubber cap from the RF port. Connect the RF cable (customer supplied) from the ANTENNA port of the ACU to the RF port on the radome bottom using an 19 mm spanner. Both side of the connection cable should be terminated using suitable tools.

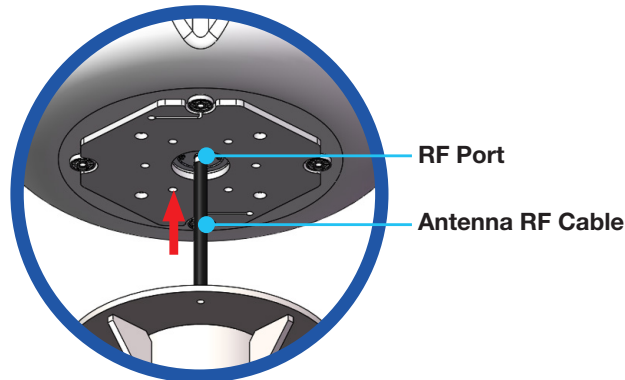

4. Put the antenna down on the mast after connecting the RF cable.



WARNING

Do not tighten excessively when using the spanner, this will damage the threads. Be careful that the connectors do not touch the mounting surface of the antenna, this might cause a critical malfunction and serious damage to the equipment.



NOTE

Make sure the followings before installing system cables.

1. All cables need to be well clamped and protected from the physical damage and exposure to heat and humidity.
2. Don't use any acutely bent cable.
3. Use watertight glands or swan neck tubes at exposed bulkheads or deck heads where the cable passes through.
4. Install recommended size cables. Refer to "**3.3 System Cables (Customer Supplied)**" on **page 18** to see cable requirements.

5.6 Mounting Antenna on Mast

Use the mounting holes to secure the antenna to the mast.

1. Bring M8 x 40L Hex Bolt sets for antenna-mast assembly from the ACU box.
2. Place the antenna on the mast and align the mounting holes of the antenna with those of the mast.
3. Before assembling bolts, apply Loctite #263 to the bolt threads to ensure the bolts are fastened firmly. Insert the bolts and washers from under the mast into the radome, and lightly tighten them by hand into the built-in nuts on the bottom of radome. Install 4 bolts in a criss-cross sequence as shown in the figure.
4. After installing all 4 bolt sets, fully tighten the bolts using a torque wrench.

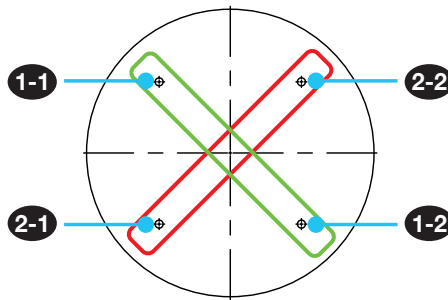

Figure 14: Installing Sequence of Bolts

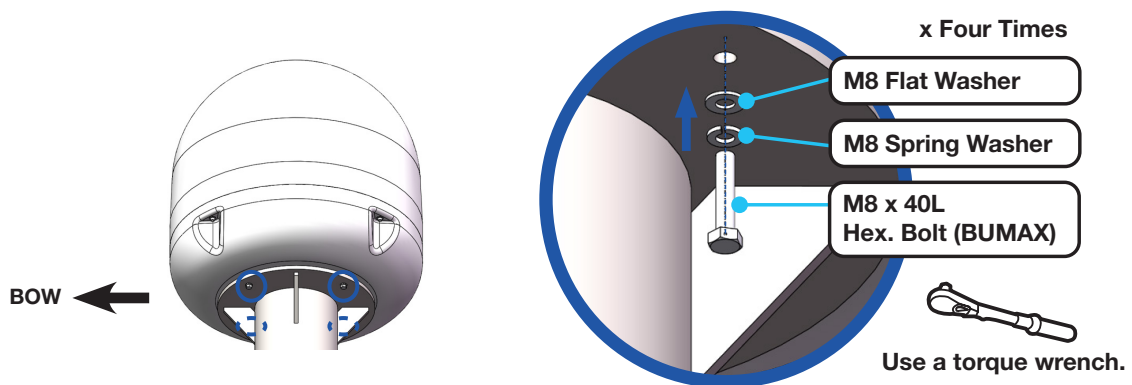

Figure 15: Installing Bolts for Antenna-Mast Assembly

NOTE



- Position the antenna with the BOW direction parallel to the center line of the ship.
- Make sure the cable from the mast is aligned with the cable entry on the bottom of antenna for stable connection.
- Refer to "**11.1 Appendix A. Tightening Torque Specification**" on page 92 for the bolt tightening torque.

WARNING



If a bolt does not fit into the mounting hole when installing the bolt by hand, stop installing and check the bolt size. **DO NOT** tighten the bolts forcefully. It may cause damage to the inner threads of the mounting holes of antenna. In this case, the damage is not covered by the warranty.

Chapter 6. Installing Below Deck Unit (BDU)

6.1 Selecting BDU Installation Site

The ACU should be installed below the deck in a location that is dry, cool and ventilated. The front panel of ACU should be easily accessible to users.

6.2 ACU Dimensions

Confirm the dimension of the ACU before installing it.

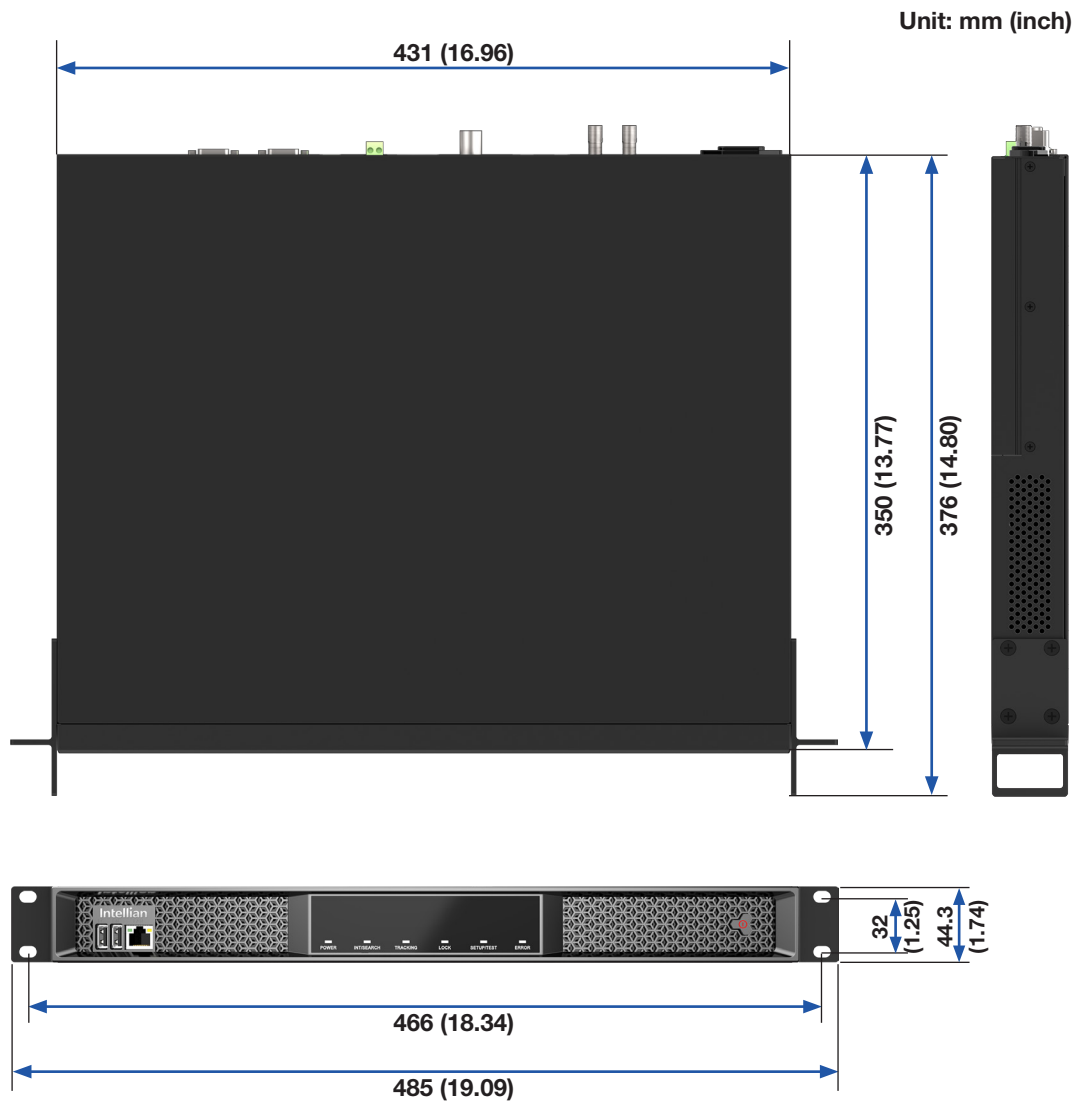

Figure 16: ACU Dimensions

6.3 Mounting ACU on 19-inch Rack

The ACU can be installed to a 19" rack using the two rack mount brackets which can be found in the ACU box. Attach the rack mount brackets to the sides of the ACU using flat head screws. Connect cables to the back side of the ACU.



Figure 17: 19-inch Rack Mount ACU



WARNING

Ensure that the cables connected to the ACU are long enough to prevent damage when the ACU is pulled out from the rack.

6.4 Antenna System Configuration

For the proper operation of the satellite communication system, the required components must be connected as shown in the figure. Separate purchase of a satellite modem and ship's gyrocompass may be needed.

6.4.1 Single Antenna System Configuration

The basic system consists of one VSAT antenna and one ACU. Connect the cables according to the following configuration.

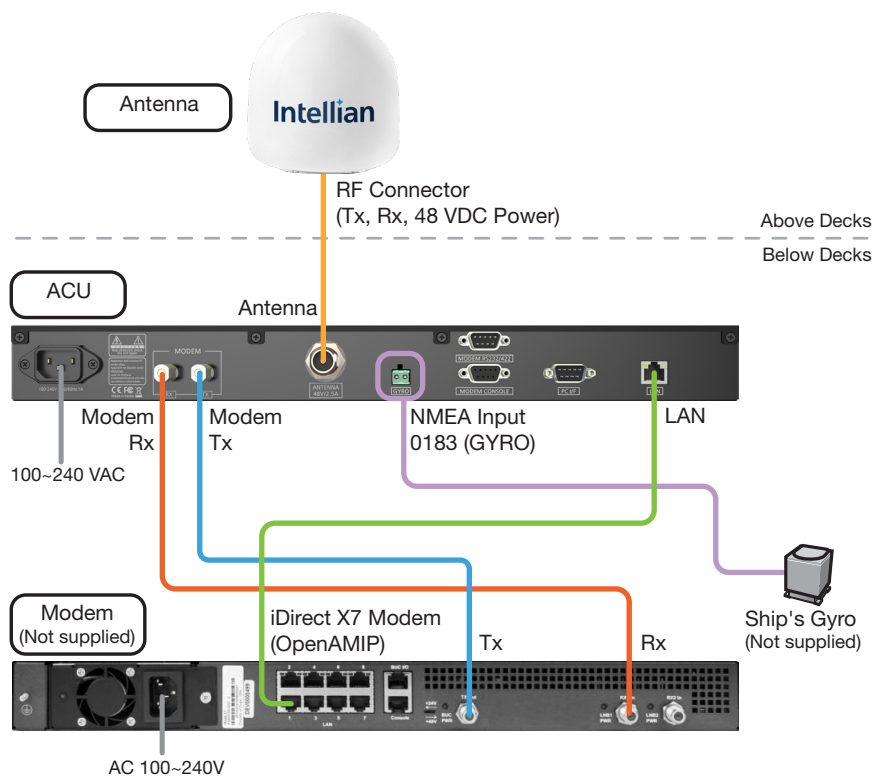

Figure 18: Antenna System Configuration



NOTE

The dual antenna system is not configurable with this system.

6.5 ACU Cable Connection

6.5.1 ACU Back Panel Connectors

The following figure shows the ACU back panel.

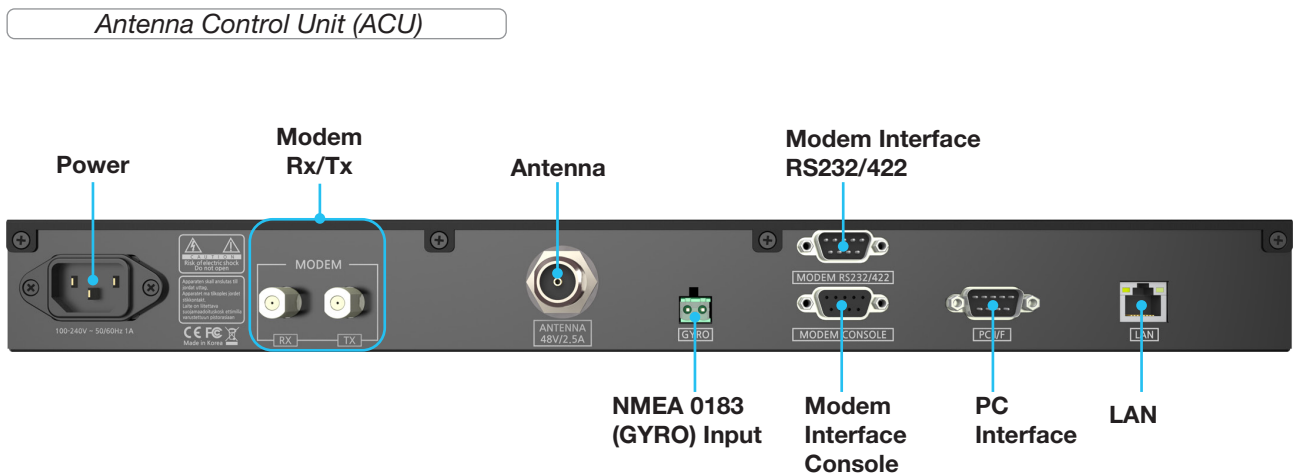
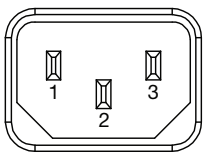

Figure 19: ACU Back Panel Connectors

6.5.2 ACU Connector Pinout Guide

Check the following connector pinout information applied to the connection ports of the ACU.

- **Power Connector**



IEC 320 C14 Plug Male

| Pin | Signal |
|-----|---------|
| 1 | NEUTRAL |
| 2 | GND |
| 3 | LIVE |

- **Modem Rx and Tx Connectors**

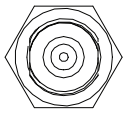

RF F Type Female

| Conductor | Function |
|-----------|----------|
| Inner | DATA |
| Outer | GND |

- **Antenna Connector**

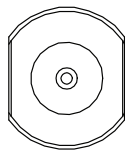

RF N Type Female

| Conductor | Function |
|-----------|-------------------------------|
| Inner | RX, TX, FSK, REFERENCE, POWER |
| Outer | GND |

- **NMEA 0183 Input**

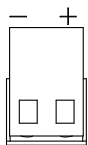

2-Pin Terminal Block

| Pin | Signal |
|-----|-------------|
| - | HEADING GND |
| + | HEADING IN |

- **Modem Interface - RS232 & RS422 Connector**

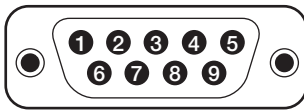

D-Sub 9-Pin Male

| Pin | Signal |
|-----|-----------------------|
| 1 | N/C |
| 2 | MODEM TX / MAX422 RX+ |
| 3 | MODEM RX / MAX422 TX+ |
| 4 | N/C |
| 5 | GND |
| 6 | N/C |
| 7 | MAX422 RX- |
| 8 | MAX422 TX- |
| 9 | N/C |

- **Modem Interface - Console Connector**

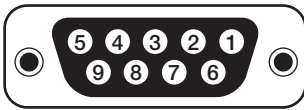

D-Sub 9-Pin Female

| Pin | Signal |
|-----|------------|
| 1 | GND |
| 2 | GPS_OUTA |
| 3 | MODEM_LOCK |
| 4 | MUTE 0 |
| 5 | N/C |
| 6 | GPS_OUTB |
| 7 | EXM_AGC |
| 8 | MUTE 1 |
| 9 | N/C |

- **PC Interface - RS232 Connector**

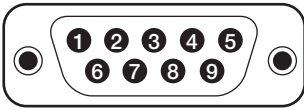

D-Sub 9-Pin Male

| Pin | Signal |
|-----|---------------------|
| 1 | N/C |
| 2 | PC RX |
| 3 | PC TX |
| 4 | N/C |
| 5 | GND |
| 6 | N/C |
| 7 | IARM TO PC_ DBG_ TX |
| 8 | PC TO IARM_ DBG_ RX |
| 9 | N/C |

- **LAN Connector**

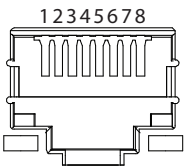

RJ-45 Female

| Pin | Signal |
|-----|--------|
| 1 | TX- |
| 2 | TX+ |
| 3 | RX- |
| 4 | N/C |
| 5 | N/C |
| 6 | RX+ |
| 7 | N/C |
| 8 | N/C |

6.5.3 Connecting Power to ACU

Connect the power cord from the power supply to the power connector (100~240 VAC) of ACU.

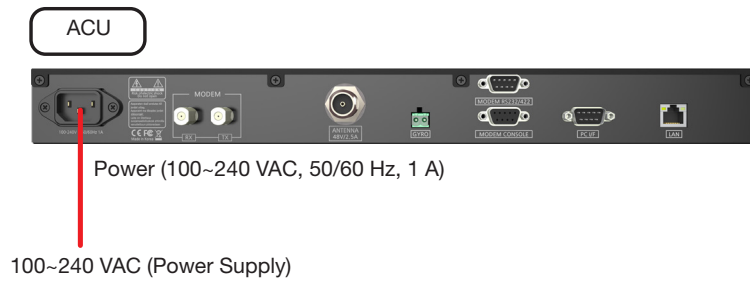

Figure 20: Connecting Power to ACU

6.5.4 Connecting ACU to Antenna

Connect an **Antenna RF cable (N to N)** (customer supplied) from the **ANTENNA (N)** port of the ACU to the **RF (N)** port of radome (antenna).

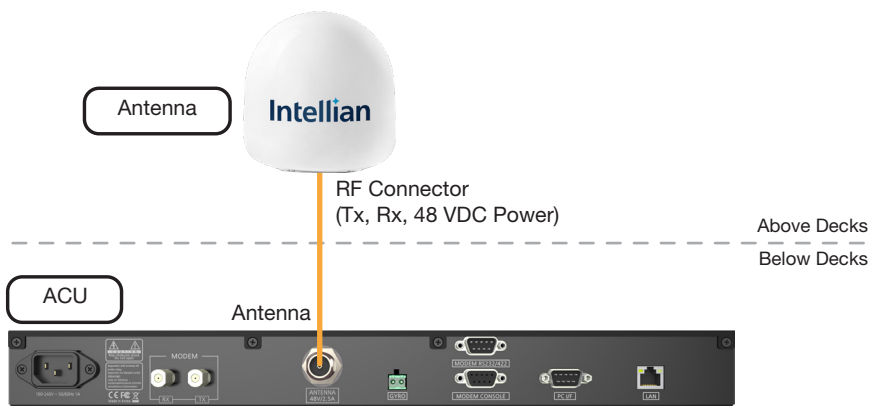

Figure 21: ACU to Antenna Cable Connection

6.5.5 Connecting ACU to Modem

1. Connect a **RF cable (F to F)** from the **MODEM Rx (F) port** of the ACU to the **Rx (F) port** of the modem.
2. Connect another **RF cable (F to F)** from the **MODEM Tx (F) port** of the ACU to the **Tx (F) port** of the modem.
3. When using the OpenAMIP modem protocol, connect an **Ethernet cable** from the **LAN (RJ45) port** of the ACU to a **LAN (RJ45) port** of the modem.

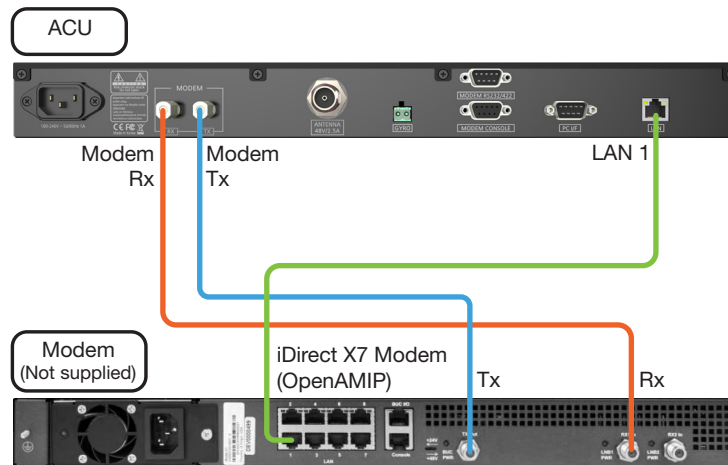

Figure 22: ACU to Modem Cable Connection

6.5.6 Connecting ACU to Ship Gyrocompass

For satellite tracking, connect a gyrocompass used on ship to the antenna system through the gyrocompass interface of the ACU. Intellian ACU supports NMEA 0183 (GYRO) gyrocompass input.

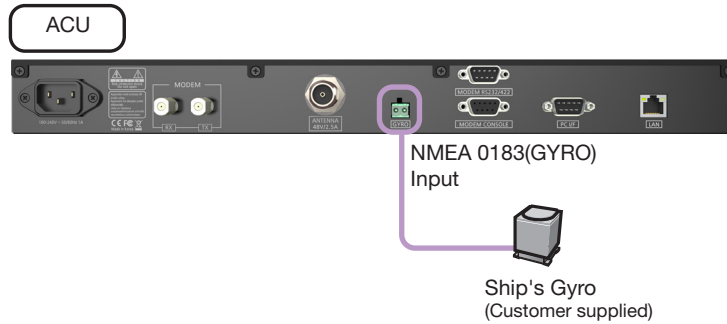
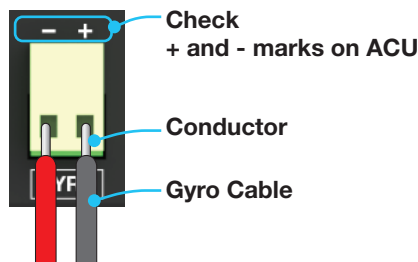

Figure 23: ACU to Ship Gyrocompass Cable Connection

How to Connect NMEA 0183 Gyrocompass Cable

1. Using a Phillips screwdriver, loosen the two screw terminals by rotating them counterclockwise.
2. Strip wires up to 5 mm (0.2"). Do not solder the cables.
3. Insert conductor of gyro cable to the terminal block. The polarity of the terminal is indicated on the ACU with + and - marks. After checking the polarity, connect the cables correctly.



4. Fully tighten the screws by rotating them clockwise to clamp the wires securely.
5. Insert the terminal block with gyro cables to the **NMEA 0183(GYRO) port** of ACU.

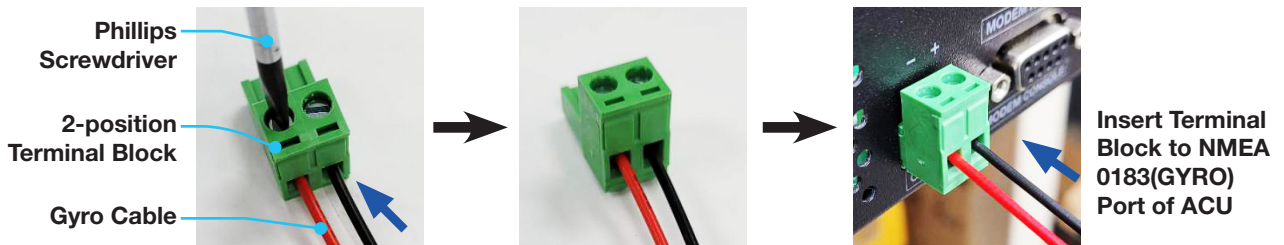

Figure 24: NMEA 0183 Gyrocompass Cable Connection

6.6 ACU to PC Communication Setup

You can establish the data communication between the Antenna Control Unit (ACU) and PC using one of the following methods.

6.6.1 TCP/IP Connection

Connection through Front Panel Management Port

The network is automatically configured by DHCP with no additional PC IP configuration.

1. Connect an Ethernet cable from the Management LAN port on the front panel of ACU to a LAN port of PC.
2. The network connection is established automatically.
3. Use the following IP address to access Intellian *AptusNX* page.
 - **IP Address: 192.168.2.1 (Default)**

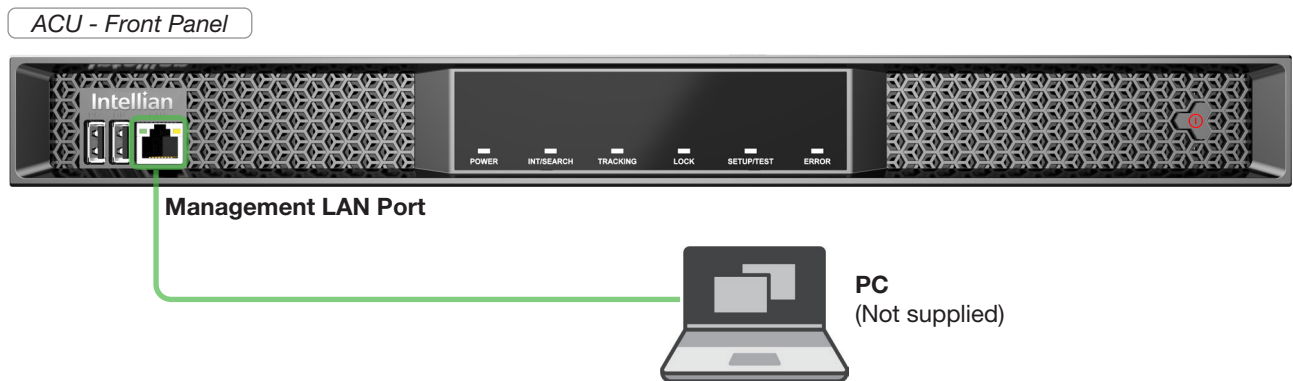

Figure 25: Front Panel Management LAN Port Connection

6.6.2 USB Connection

Using Left Side USB (Serial) Port on ACU Front Panel

Connect a USB Cable (A to A) (customer supplied) from the left side USB (serial) port on the front panel of ACU to PC for monitoring and controlling the antenna system.



NOTE

- The left side USB port is only for certified engineers' use only.
- Accessing *AptusNX* and *iARM* upgrade are NOT supported through the serial USB connection.

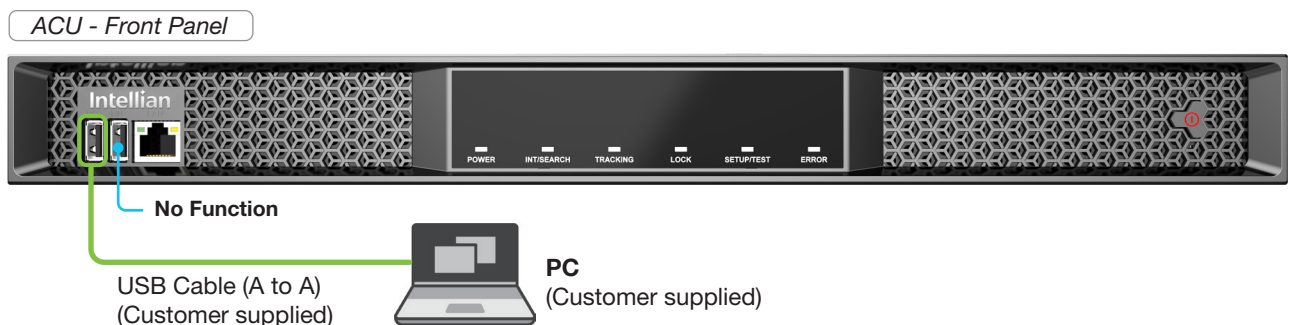

Figure 26: Front Panel USB Port Connection

Chapter 7. Operating Install Wizard

7.1 Turning On System

Make sure the antenna has a clear view of the sky. Press the **POWER** button on the front panel of the Antenna Control Unit (ACU), then wait a few minutes for system startup. Once the antenna finds the satellite, the **POWER** indicator will turn **Green**.

7.2 Accessing AptusNX

The network is automatically configured by DHCP with no additional PC IP configuration.

1. Connect an Ethernet cable from the Management LAN port on the ACU front panel to a LAN port of PC.
2. The network connection is established automatically.
3. Use the following IP address to access Intellian *AptusNX* page.
 - **IP Address: 192.168.2.1 (Default)**
4. Log into the *AptusNX* by entering User ID and Password.
 - **User ID: intellian (Default)**
 - **Password: 12345678 (Default)**

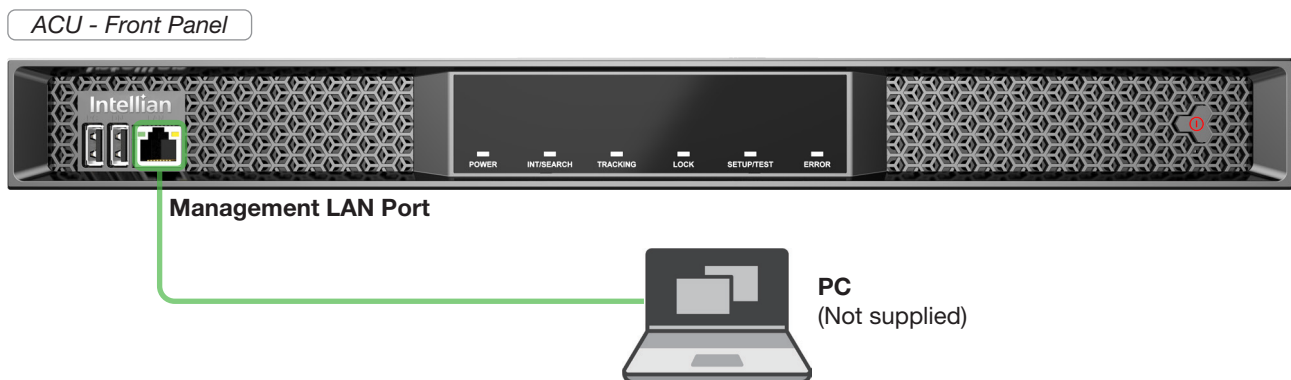
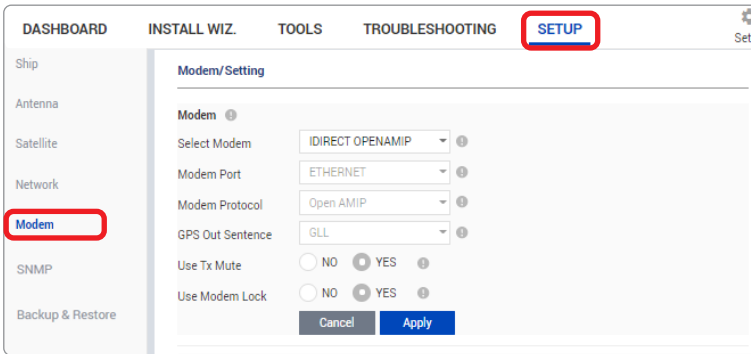

Figure 27: Front Panel Management LAN Port Connection

7.3 Modem Configuration

Before starting installation wizard, set up the modem configuration.

1. After accessing the *AptusNX* main page, go to the **SETUP** → **Modem** on the main menu then follow these steps.



2. Select your modem type from the **Select Modem** drop-down list for loading a pre-configuration of modem. The setting parameters related to the modem interface will be set automatically once the modem type is selected. If you select **USER SETTING** from the **Select Modem** drop-down list, the settings can be changed manually. Click the **Apply** button.

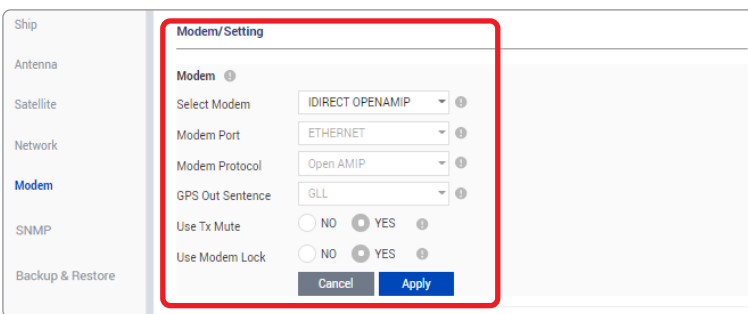

3. Enter the modem setting values to configure the modem. Refer to the information provided by your service provider. Click the **Apply** button.

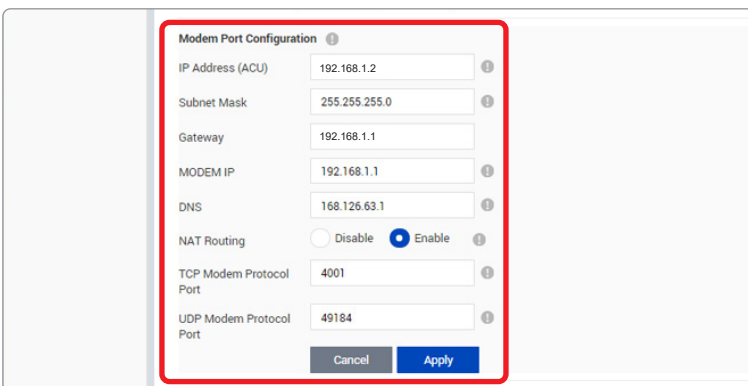

4. On the pop-up window, select the checkbox if you want the system to perform the **iARM Save & Reboot** automatically. Then, click the **Confirm** button.

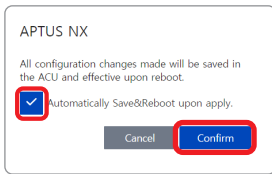

5. Reboot the system.

7.4 Starting Install Wizard

The Install Wizard will give you a guide by going through the steps of setup for the antenna system commissioning. We highly recommend using this wizard to complete the installation and commissioning of the system. You can exit the wizard at any time by clicking the **Finish** button. You can also skip steps by clicking the **Next** button. Before you start, make sure the basic devices (antenna, modem, etc) are connected to the ACU properly. After accessing the *AptusNX* main page, go to the **INSTALL WIZ.** on the main menu then follow these steps.



NOTE

Refer to the "**Chapter 8. Using AptusNX**" on page 54 for detailed description of each function.

✓ **Welcome Page**

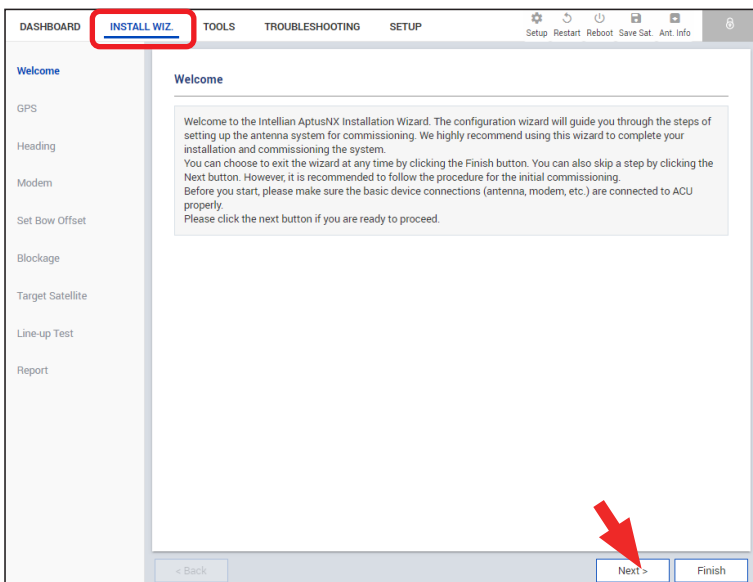

Welcome message is displayed. Click the **Next** button to start.

✓ **Step 1: GPS**

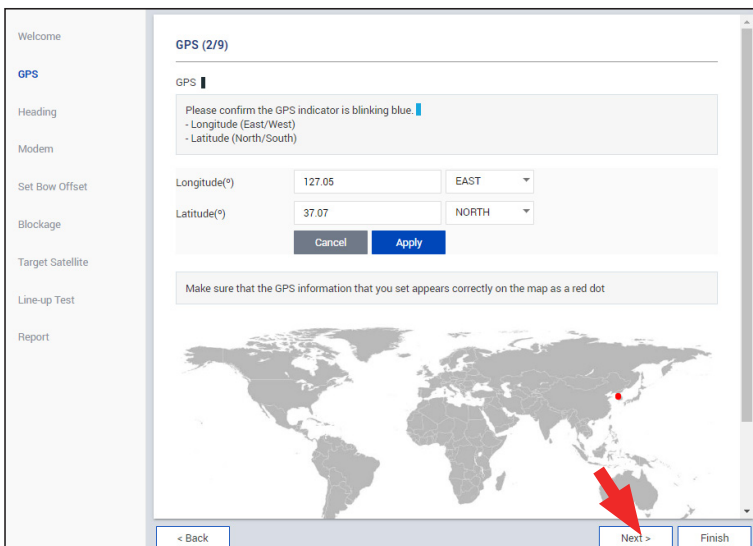

Set the GPS position of the vessel for the satellite searching. Check the GPS status connected to the antenna system. The colored indicator next to the title shows the GPS status. Make sure the GPS indicator is Blue (blinking).

- Blue (blinking): The system received a correct GPS signal.
 - Red: The GPS signal is abnormal, or the received value is incorrect (Error).
 - Black: The system has not received any GPS signal. You can enter the GPS value manually to set the GPS position.
- Click the **Next** button to go to the next step.

✓ **Step 2: Heading**

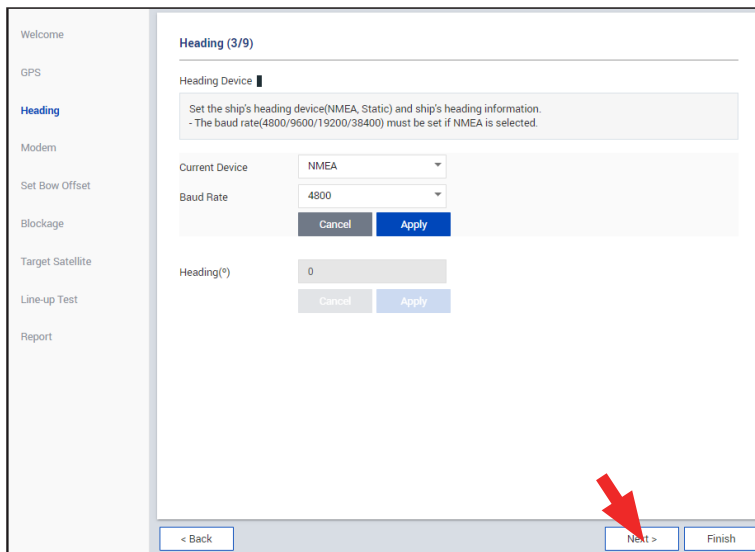

Set the ship's heading device. The colored indicator next to the title shows the heading device connection status.

- Blue: Ship's heading device is connected.
- Black: Ship's heading device is not connected.

If a gyrocompass is connected, choose the device type from the **Current Device** drop-down list. Then, click the **Apply** button. If no gyrocompass is connected, choose **NONE** for the **Current Device** from the drop-down list. Then, click the **Apply** button.

NOTE: Skip "Step 4: Set Bow Offset" if no gyrocompass is connected.

Click the **Next** button to go to the next step.

✓ **Step 3: Modem**

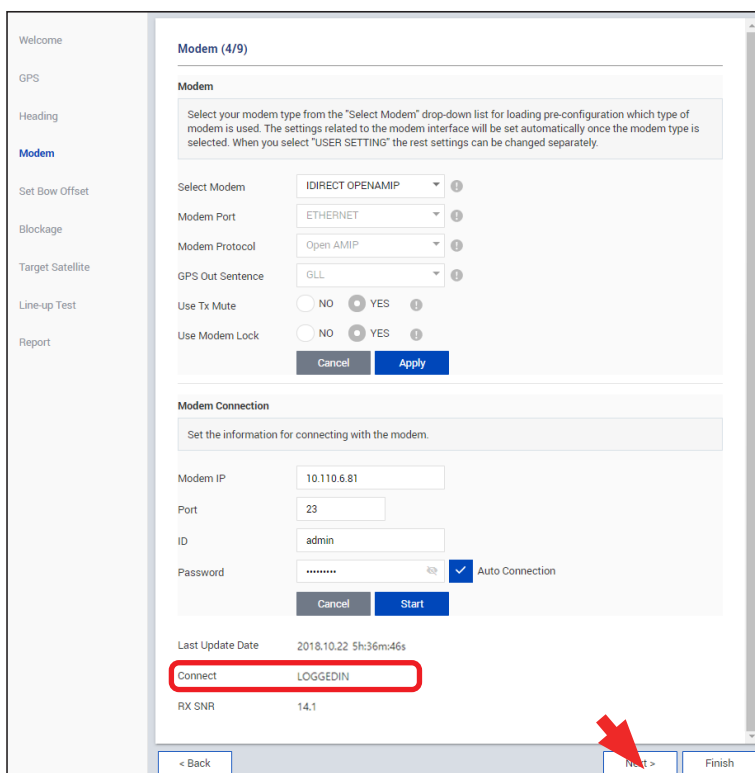

*** This function is not supported depending on the modem type.**

Select your modem type from the **Select Modem** drop-down list for the modem configuration. The setting parameters related to the modem interface will be set automatically once the modem type is selected. If you select **USER SETTING** from the **Select Modem** drop-down list, the settings can be changed manually. Make sure the **Modem Connection** is in **LOGGEDIN** status.

Click the **Next** button to go to the next step.

✓ **Step 4: Set Bow Offset**

For setting the bow offset, a trackable satellite must be selected. There are two methods for tracking a target satellite.

(Option 1: Using Beam Switch Type)

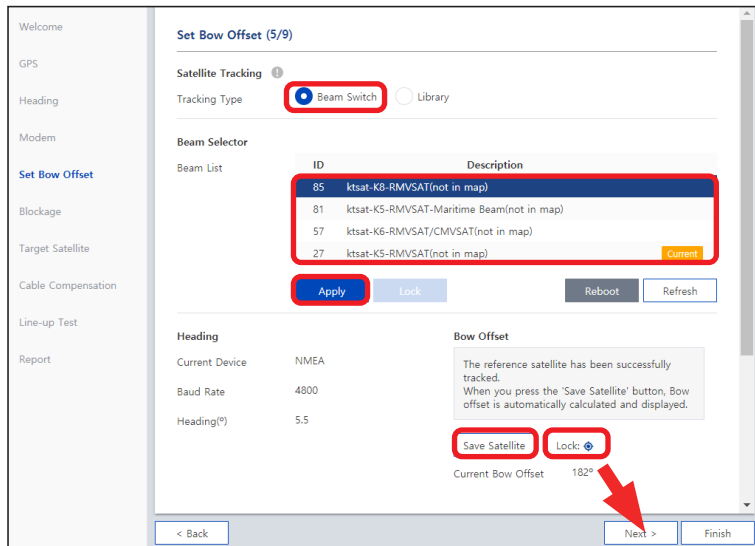

**** This function is not supported depending on the modem type.***

- **Step 1:** Choose the **Beam Switch** for the **Tracking Type**.
- **Step 2:** Select a satellite under the Beam List, then click the **Apply** button.

Wait while the antenna terminal tracks the satellite.

- **Step 3:** Make sure the **Lock** is on, then click the **Save Satellite** button in the **Bow Offset** menu to save the BOW offset information to ACU.

Click the **Next** button to go to the next step.

(Option 2: Using Library Type)

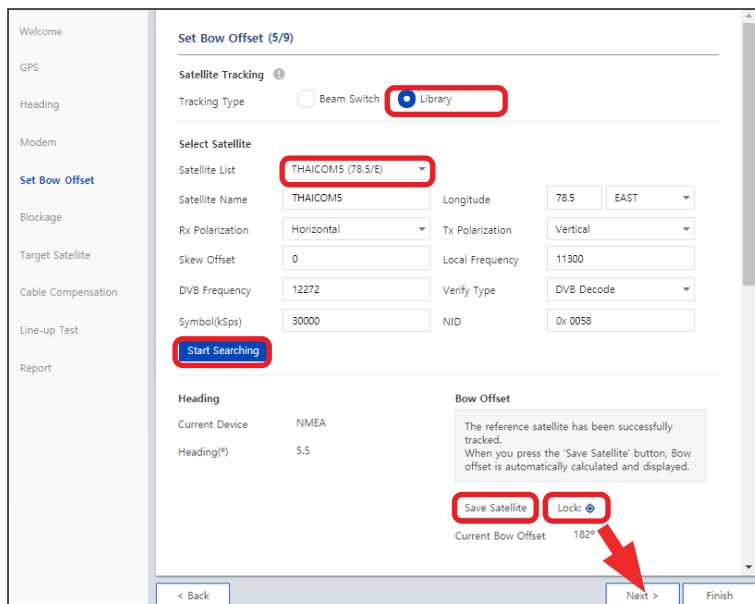

- **Step 1:** Choose the **Library** button on the **Tracking Type**.
- **Step 2:** Select a satellite under the **Satellite List**, then click the **Start Searching** button.

Wait while the antenna terminal tracks the satellite.

- **Step 3:** Turn on the **Lock**, then click the **Save Satellite** button in the **Bow Offset** menu to save the BOW offset information to the antenna.

Click the **Next** button to go to the next step.

✓ **Step 5: Blockage**

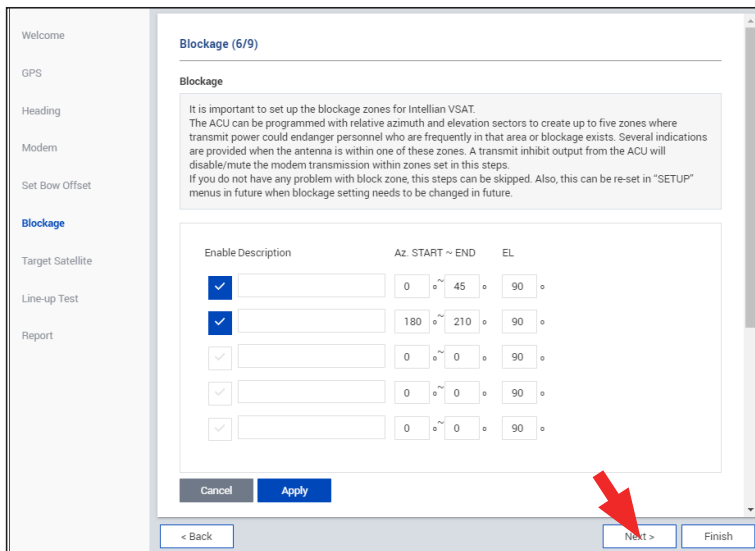

It is important to set up the blockage zones for Intellian VSAT. The VSAT system can be programmed with relative azimuth and elevation sectors to create up to five zones for the transmission mute.

The **AZ START** is the relative azimuth angle where the blockage starts, and the **AZ END** is the relative azimuth angle where the blockage ends (Range: 0 ~ 360).

The **EL** is the elevation angle where the blockage is set (Range: 0 ~ 90). The blockage is activated below the elevation angle.

Click the **Next** button to go to the next step.

✓ **Step 6: Target Satellite**

Set the target satellite to track. There are two methods for selecting a target satellite.



NOTE

The following images in this step show when the Open AMIP modem is used.

(Option 1: Using Satellite Controlled by Modem)

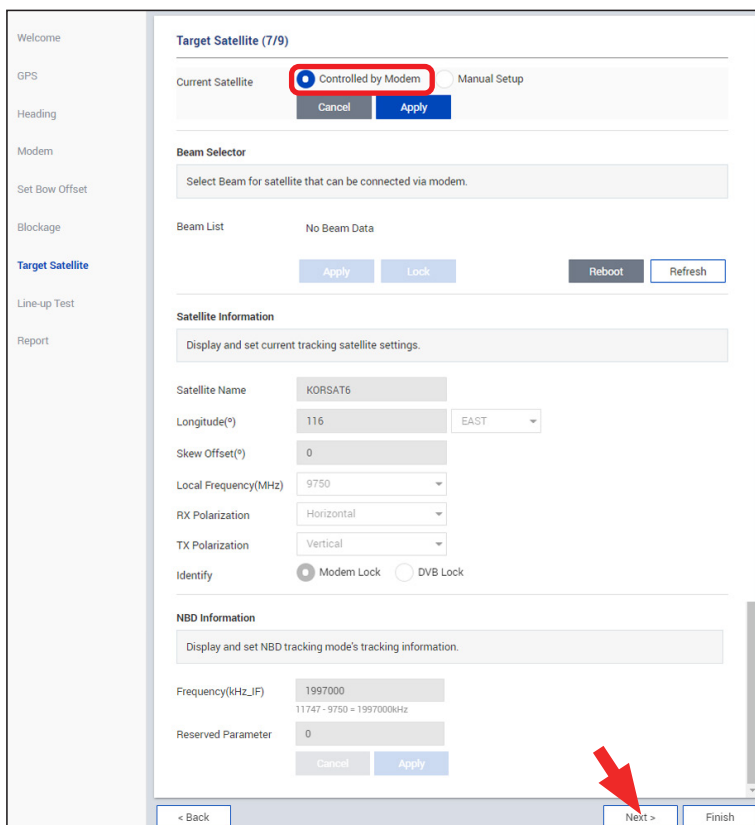

*** This function is not supported depending on the modem type.**

This method is generally recommended.

Select the **Controlled by Modem** for the **Current Satellite**. Then, the current satellite and NBD information will be displayed automatically.

Click the **Next** button to go to the next step.

(Option 2: Using Manual Setup)

Welcome

GPS

Heading

Modem

Set Bow Offset

Blockage

Target Satellite

Line-up Test

Report

Target Satellite (7/9)

Current Satellite Controlled by Modem **Manual Setup**

Cancel Apply

Satellite Information

Display and set current tracking satellite settings.

Satellite Name

Longitude(°) EAST

Skew Offset(°)

Local Frequency(MHz)

RX Polarization

TX Polarization

Identify Modem Lock DVB Lock

NBD Information

Display and set NBD tracking mode's tracking information.

Frequency(kHz_IF)
11747 - 9750 = 1997000kHz

Reserved Parameter

Cancel Apply

< Back Next > Finish

If you did not set the modem connection, select the **Manual Setup** for the **Current Satellite**. Then enter the satellite and NBD information manually to track a satellite. Click the **Apply** button.

Click the **Next** button to go to the next step.

✓ **Step 7: Line-up Test**

Perform a line-up test by the satellite operator to confirm antenna performance and operation status.

(Option 1: Using iDirect Open AMIP Modem)

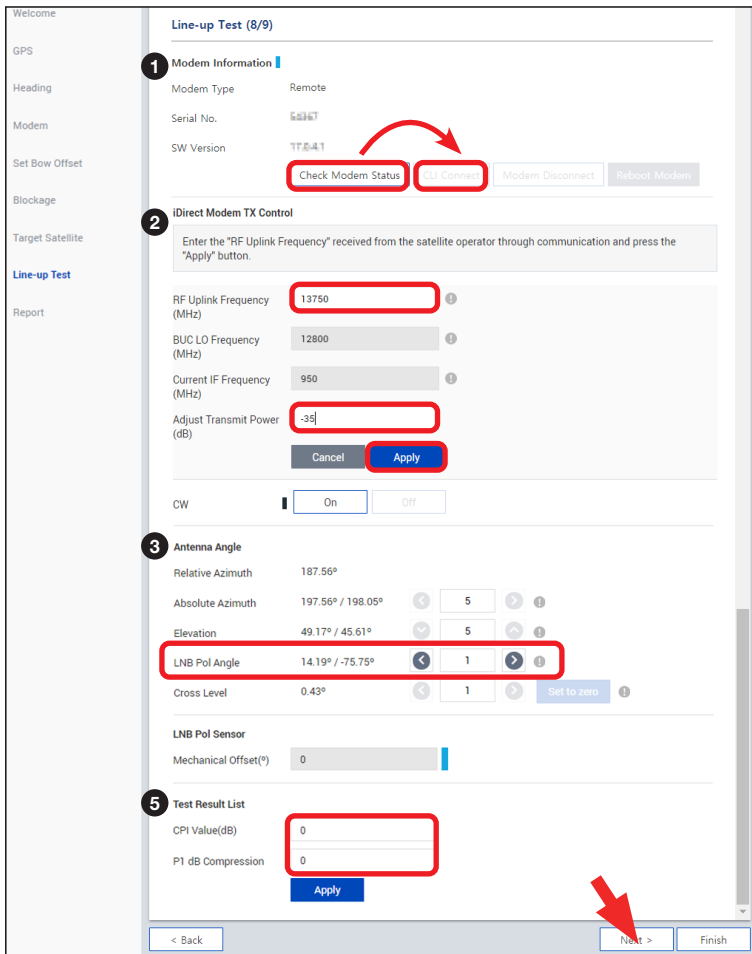

**** This function is not supported depending on the modem type.***

1. Check modem status for connection readiness by clicking the **Check Modem Status** button. Then connect to iDirect Open AMIP modem by clicking the **CLI Connect** button.
 2. Enter the CW signal frequency provided by your satellite operator into the **RF Uplink Frequency**. *This menu can be edited when the antenna is connected to iDirect Open AMIP modem and the CW is off.* Adjust the transmit power of the frequency by entering the value into the **Adjust Transmit Power**, then click the **Apply** button to transmit the signal.
 3. Adjust the **LNB Pol Angle** by clicking the Left or Right Arrow Button and then the Mechanical Skew Offset is Saved. The Mechanical Skew Offset is set within ± 2 degrees.
 4. Enter the **Test Result** value received from the satellite operator and click the **Apply** button.
- Click the **Next** button to go to the next step.

Refer to the following table for a detailed explanation of each menu.

| No. | Item | Description |
|-----|--------------------------|--|
| ① | Modem Information | <p>Checks the iDirect Open AMIP modem information. The indicator right of the title shows the device connection status. (Blue: a iDirect Open AMIP modem is connected. Black: a iDirect Open AMIP modem is not connected.)</p> <ul style="list-style-type: none"> • Modem Type: Displays the iDirect Open AMIP modem type. • Serial No.: Displays the iDirect Open AMIP modem's serial number. • SW Version: Displays the iDirect Open AMIP modem's SW version. <p>- Check Modem Status: Before the CLI connection, check modem status for connection readiness by clicking the Check Modem Status button.</p> <p>- CLI Connect : Connect to iDirect Open AMIP modem by clicking the CLI Connect button.</p> <p>- CLI Disconnect: Disconnect from iDirect Open AMIP modem by clicking the CLI Disconnect button.</p> |
| ② | iDirect Modem Tx Control | <p>Adjusts the modem frequency to receive optimal signal. This menu can be edited when the antenna is connected to iDirect Open AMIP modem and the CW is off. Click the Apply button to apply the settings to the system.</p> <ul style="list-style-type: none"> • RF Uplink Frequency (MHz): Enters the RF uplink frequency provided by your satellite operator. • BUC LO Frequency (MHz): The BUC LO frequency is applied automatically. The value is assigned according to the satellite band. • Current IF Frequency (MHz): The current IF frequency is applied automatically. The value is RF Uplink Frequency value - BUC LO Frequency. <p>The following menus are performed to adjust the transmit power of the frequency.</p> <ul style="list-style-type: none"> • Adjust Transmit Power: Adjust the power calibration value by entering the value. • CW: Select whether to use the modulation function or not (On or Off). The indicator next to the title shows the CW status. (Blue: CW is on. Black: CW is off.) To edit the details of the iDirect Modem Tx Control menu, you must keep this function off. |
| ③ | Antenna Angle | <p>Adjusts the antenna angle to receive optimal signal.</p> <ul style="list-style-type: none"> • Relative Azimuth: Displays the relative azimuth angle. • Absolute Azimuth: Adjust the absolute azimuth angle using the arrow keys. • Elevation: Adjust the elevation angle using the arrow keys. • LNB Pol Angle: Adjust the LNB Pol angle using the arrow keys. • Cross Level: Adjust the cross level angle using the arrow keys. Click the Set to zero button to set zero angle automatically. |
| ④ | LNB Pol Sensor | <p>Displays the Mechanical Offset value of the LNB Pol Sensor. The indicator right of the title shows the LNB Pol Sensor status. (Blue: the LNB pol sensor is on. Black: the LNB pol sensor is off.)</p> <ul style="list-style-type: none"> • Mechanical Offset: Displays the mechanical offset value of the LNB Pol Sensor. |
| ⑤ | Test Result List | <p>Enters the test result value received from the satellite operator.</p> <ul style="list-style-type: none"> • CPI Value (dB): Enter the CPI value. • P1 dB Compression: Enter the P1 dB compression. |

(Option 2: Using Other Modems)

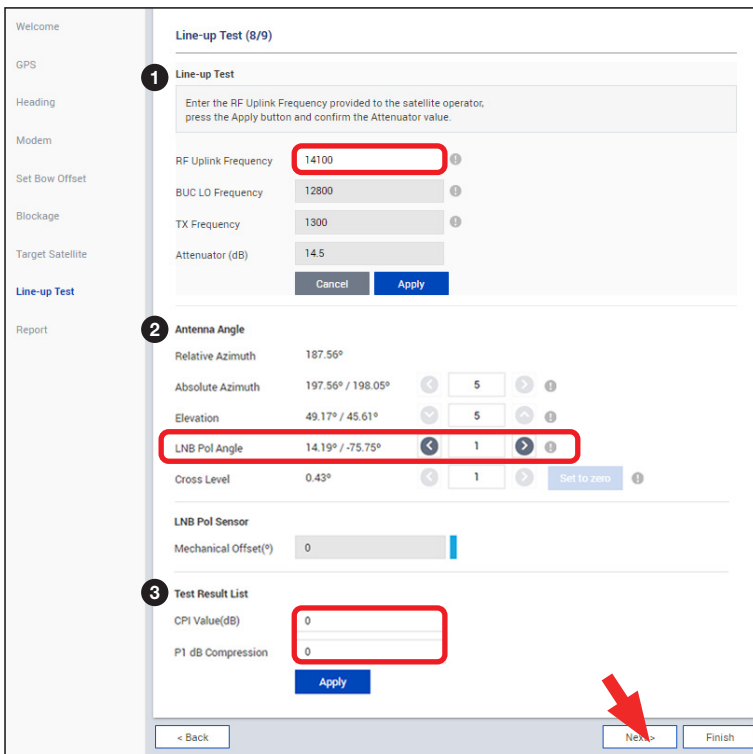

1. Enter the CW signal frequency provided by your satellite operator into the **RF Uplink Frequency**, then click the **Apply** button to transmit the signal. (This CW signal frequency must be applied to the modem. The setting process differs depending on the modem, refer to the instruction manual of the modem.)
2. Adjust the **LNB Pol Angle** by clicking the Left or Right Arrow Button and then the Mechanical Skew Offset is Saved. The Mechanical Skew Offset is set within ± 2 degrees.
3. Enter the **Test Result** value received from the satellite operator. Click the **Next** button to go to the next step.

Refer to the following table for a detailed explanation of each menu.

| No. | Item | Description |
|-----|--------------------------|---|
| ① | iDirect Modem Tx Control | Adjusts the modem frequency to receive optimal signal. Click the Apply button to apply the settings to the system. <ul style="list-style-type: none"> • RF Uplink Frequency (MHz): Enters the RF uplink frequency provided by your satellite operator. • BUC LO Frequency (MHz): The BUC LO frequency is applied automatically. The value is assigned according to the satellite band. • Tx Frequency: The Tx frequency is applied automatically. The value is RF Uplink Frequency value - BUC LO Frequency. • Attenuator (dB): The attenuator is applied automatically. |
| ② | Antenna Angle | Adjusts the antenna angle to receive optimal signal. <ul style="list-style-type: none"> • Relative Azimuth: Adjust the relative azimuth angle. • Absolute Azimuth: Adjust the absolute azimuth angle. • Elevation: Adjust the elevation angle. • LNB Pol Angle: Adjust the LNB Pol angle. |
| ③ | Test Result List | Enters the test result value received from the satellite operator. <ul style="list-style-type: none"> • CPI Value (dB): Enter the CPI value. • P1 dB Compression: Enter the P1 dB compression |

✓ **Step 8: Report**



NOTE

The following image shows when the system is using the Open AMIP modem. In case of using other modems, the displayed items on the Report may change.

| Engineer Information | |
|----------------------|----------------------|
| Name | <input type="text"/> |
| Company | <input type="text"/> |
| Certification ID | <input type="text"/> |
| Email | <input type="text"/> |

| Line-up Test | |
|---------------------|----------------------|
| Test Result | |
| Ticket Number | <input type="text"/> |
| Operator | <input type="text"/> |
| CPI Value(dB) | 14.5 |
| L-Band Tx Freq(MHz) | 1300 |

| System Information | |
|----------------------|----------------------|
| Antenna Information | |
| <input type="text"/> | <input type="text"/> |

The configuration report is displayed.

You can save the results to the ACU by clicking the **Save Report** button and download the report file (.json) by clicking the **Export** button.

Click the **View Last Report** to check the recently saved report information including the saved date and time.

After complete the steps, click the **Finish** button.

Chapter 8. Operating ACU

8.1 ACU Front Panel View

The following figure shows the ACU's front panel.

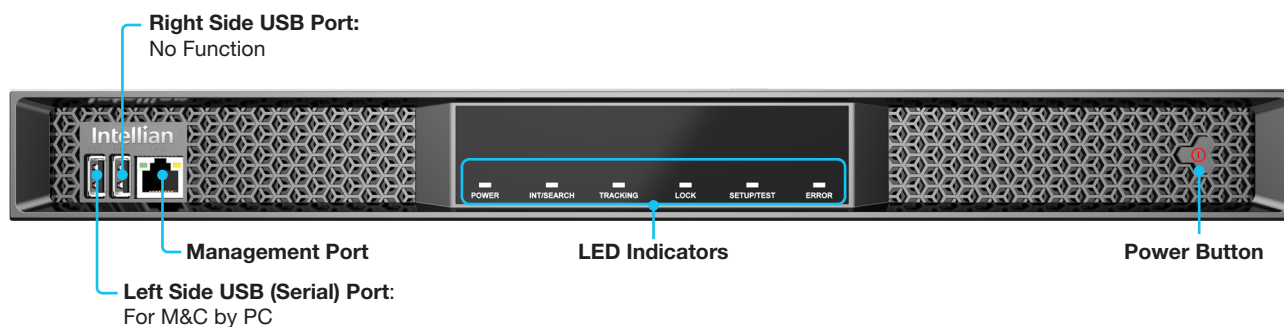

Figure 28: ACU Front Panel View

The following table shows status indicators on the ACU.

| LED Indicator | Color | Description |
|-----------------------|-------------------------|--|
| POWER | Steady Green | The ACU is powered on. |
| | Off | The ACU is powered off. |
| INT/SEARCH | Steady Green | The antenna is searching a satellite. |
| | Blinking | The antenna is initializing. |
| TRACKING | Steady Green | The antenna is in tracking mode. |
| INT/SEARCH & TRACKING | Blinking Simultaneously | The antenna is in unwrap mode. The antenna is controlling the adjustment of the AZ angle within the limits of movement of the AZ control means to avoid the risk of cable twist. |
| LOCK | Steady Green | The satellite is locked. |
| SETUP/TEST | Steady Green | The antenna is in Setup mode. |
| | Blinking | The antenna is in Test mode. |
| ERROR | Steady Red | The antenna is in error. |

Chapter 9. Using AptusNX

9.1 Introduction

With the embedded *AptusNX* software, the antenna can be monitored, controlled, and diagnosed remotely from anywhere, anytime through TCP/IP protocol. It saves your time and cost generated by various maintenance activities such as operating firmware upgrades, tracking parameter resets, and system diagnosis, etc..

9.2 Accessing AptusNX for ACU

1. Connect an Ethernet cable from the Management LAN port on the front panel of the ACU to a LAN port of PC. This method is generally recommended.
2. Enter the ACU IP address (**Default: 192.168.2.1**) into the address bar of web browser to login into the internal HTML page of ACU.



NOTE

AptusNX works on Internet Explorer 11 or higher (Windows 7 or higher editions), Firefox, Microsoft Edge and Chrome web browsers.

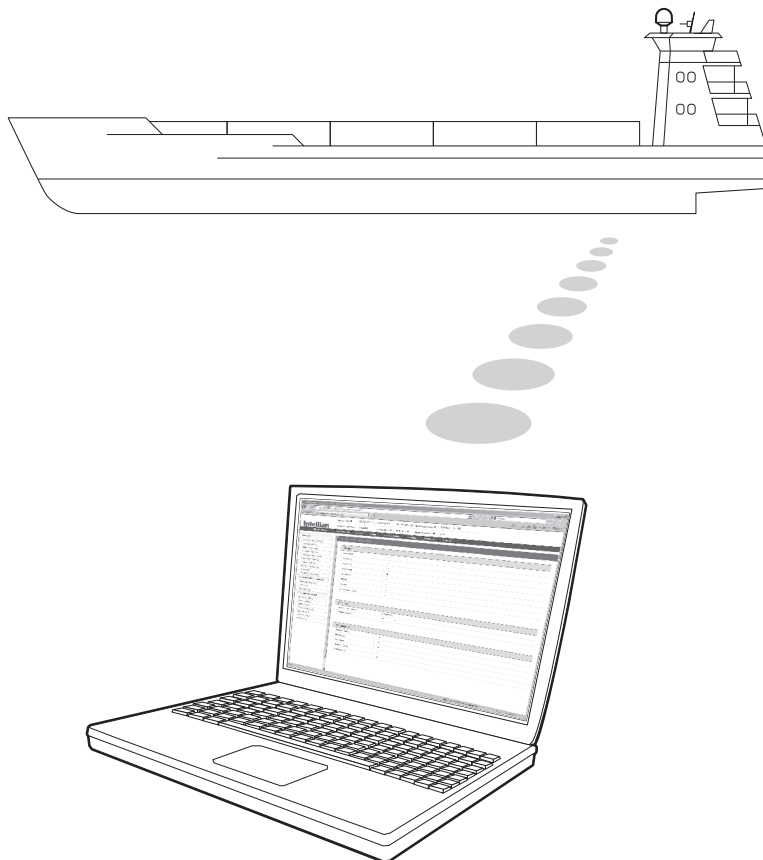

9.3 Main Page (Page Login)

The Intellian software Aptus provides different user access levels to protect the system for safe operation. Depending on the user level, the accessible range of function in the software can be limited.

1. Log into the ACU by typing in User ID and Password. The followings are the factory default values.

| User Type | User ID | Password | Access Authority |
|-----------|------------------|-----------------|--|
| Admin | <i>intellian</i> | <i>12345678</i> | All menus for monitoring and setting |
| | <i>captain</i> | <i>12345678</i> | All menus for monitoring and setting Assigns permissions to users |
| User | <i>guest</i> | <i>guest</i> | Limited menus for monitoring (Dashboard, Tools, Troubleshooting) |

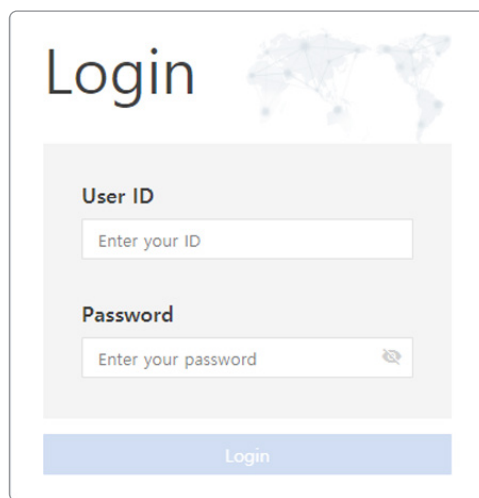



NOTE

After entering with the default password, the user must change the default password to a new password for security.

9.4 Top Menus

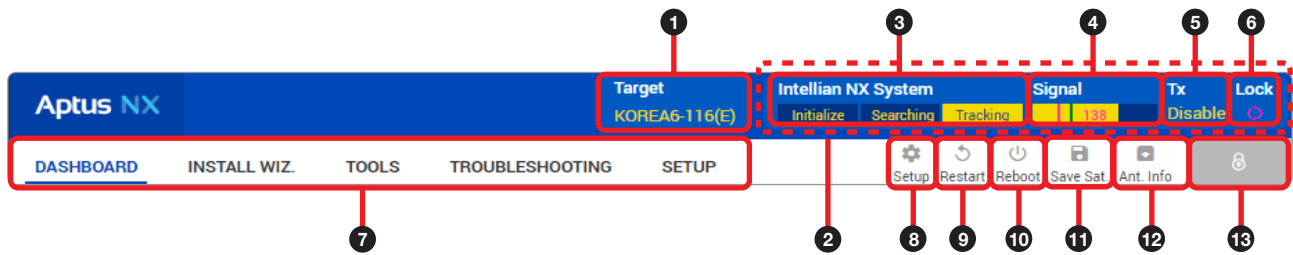
Once you log in, the following information and menus are displayed.

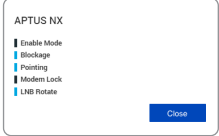

| No. | Item | Description | | | | | | | | | | | |
|-----------|--------------------------|---|-----------|-----------|----------|-------|---------|---------------|--------------------------|---|--|--------------------------|-----------------|
| ① | Target Satellite | Displays the name of the targeted satellite. | | | | | | | | | | | |
| ② | Quick Status Screen Area | When clicking this top menu area (marked as red dots), the Quick Status Screen appears. You can quickly monitor each status of the five items through the screen (Blue: enable, Black: disable).  <Quick Status Screen> | | | | | | | | | | | |
| ③ | Antenna Status Info | Displays the antenna status through a yellow indicator in the SETUP mode. <ul style="list-style-type: none"> • Initialize: the antenna system is initialized. • Searching: the antenna is searching the target satellite. • Tracking/Unwrap <ul style="list-style-type: none"> - Tracking: the antenna is tracking the target satellite. - Unwrap: in the tracking mode, antenna automatically controls adjustment of the AZ angle within the limits of movement of the AZ control means to avoid the risk of cable twist. | | | | | | | | | | | |
| ④ | Signal Level | Displays the current signal level. | | | | | | | | | | | |
| ⑤ | Tx Status | Displays whether the antenna is able to transmit data or not. | | | | | | | | | | | |
| ⑥ | Lock | Displays whether the satellite is locked or not. | | | | | | | | | | | |
| ⑦ | Main Menu | Selects the Main Menu (DASHBOARD, INSTALL WIZ, TOOLS, TROUBLESHOOTING, SETUP). Each main menu offers side menus on the left of the screen. | | | | | | | | | | | |
| ⑧ | Setup | Enters the setup mode to modify settings. The following functions are available only in setup mode. <table border="1" data-bbox="464 1541 1433 1787"> <thead> <tr> <th>Main Menu</th> <th>Side Menu</th> <th>Function</th> </tr> </thead> <tbody> <tr> <td rowspan="3">SETUP</td> <td rowspan="3">Antenna</td> <td>Antenna Angle</td> </tr> <tr> <td>Conical Scan Range Check</td> </tr> <tr> <td>Antenna Mode <ul style="list-style-type: none"> • Sets Idle Mode </td> </tr> <tr> <td></td> <td>Backup & Restore Setting</td> <td>Antenna Restore</td> </tr> </tbody> </table> | Main Menu | Side Menu | Function | SETUP | Antenna | Antenna Angle | Conical Scan Range Check | Antenna Mode <ul style="list-style-type: none"> • Sets Idle Mode | | Backup & Restore Setting | Antenna Restore |
| Main Menu | Side Menu | Function | | | | | | | | | | | |
| SETUP | Antenna | Antenna Angle | | | | | | | | | | | |
| | | Conical Scan Range Check | | | | | | | | | | | |
| | | Antenna Mode <ul style="list-style-type: none"> • Sets Idle Mode | | | | | | | | | | | |
| | Backup & Restore Setting | Antenna Restore | | | | | | | | | | | |
| ⑨ | Restart | The antenna system exits the Setup mode and switches to the normal mode (Searching/Tracking mode). | | | | | | | | | | | |
| ⑩ | Reboot | The antenna system powers off and restarts. After system initialization, the antenna switches to normal mode (Searching/Tracking mode). | | | | | | | | | | | |
| ⑪ | Save Sat. | Saves bow offset. | | | | | | | | | | | |
| ⑫ | Ant. Info | Obtains current antenna information. | | | | | | | | | | | |

| No. | Item | Description |
|-----|----------------|--|
| 13 | Account Button | Select the Account button and enter the user management menu. The Account and the Logout menu will appear. Select the Account menu to manage your account details and select the Logout menu to log out of the <i>AptusNX</i> web page. |

9.5 Account Menu

1. Click the  button to manage the user account
2. The **Account**, **System**, and **User Mgr.** menus are for the user management. Click the **Logout** button to log out of the *AptusNX* web page.

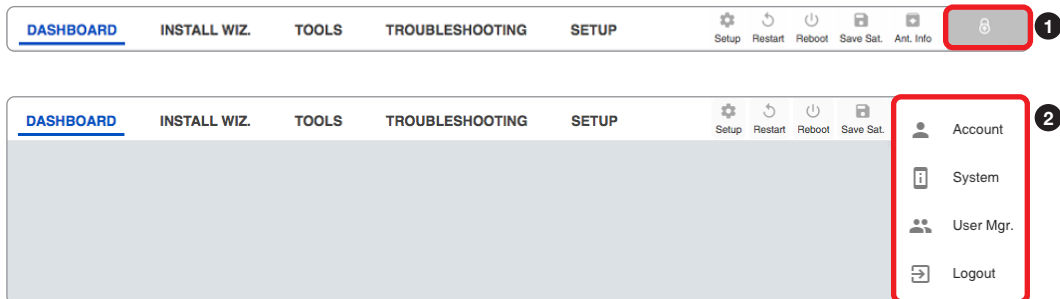

9.5.1 Account

| No. | Item | Description |
|-----|-----------------|---|
| ① | Account | Updates your password and sets time-outs. |
| ② | Change Password | <p>You can change your password.</p> <ul style="list-style-type: none"> • Current User ID: Displays your user ID. • User ID: Enter the current user ID. • Current Password: Enter the current password. • New Password: Enter the new password. • Confirm New Password: Re-enter the new password to verify that it was entered correctly. <p>Click the Change Password button to set the password to the new password. For the next login, the new password is required.</p> |
| ③ | Session | <p>You can give guests the accessibility to the AptusNX and set time-outs.</p> <ul style="list-style-type: none"> • Allow Guest Connections: Select the guest's accessibility to the system (Disable / Enable). • Idle Session Timeout: Set the idle session time-out. • Console Timeout: Set the console time-out. <p>Click the Apply button to apply the settings to the system.</p> |

9.5.2 Registration

Account

Registration 1

System

User Mgr.

2 Product

Antenna: XX-XX-XXXX

Serial Number: XXXXXXXXXXXX

3 Vessel

Has IMO Number: Yes No

Ship Name: Ship_Name

Type: Cargo vessel

Owner: Intelliantech

4 Service Provider

Service Provider 1: []

Service Provider 2: []

Service Provider 3: []

Cancel Register(Update)

| No. | Item | Description |
|-----|------------------|--|
| ① | Registration | Enter the product registration information for your convenience. Click the Register (Update) button to apply the settings to the system. |
| ② | Product | Displays the antenna information. <ul style="list-style-type: none"> Antenna: Displays the antenna name. Serial Number: Displays the antenna serial number. |
| ③ | Vessel | Enter the vessel information. You can choose either using the IMO number or not. If you have the IMO number, select Yes and enter the number. If you do not have the IMO number, select No and enter the Ship Name, Type, and Owner information. <ul style="list-style-type: none"> Has IMO Number: Select whether using the IMO number or not. IMO Number: Enter the IMO number. Ship Name: Enter the ship name. Type: Enter the ship type. Owner: Enter the owner's name. |
| ④ | Service Provider | Enter the information of your service provider. <ul style="list-style-type: none"> Service Provider 1/2/3: Enter the names of service providers. |

9.5.3 System

Account
System Print

Registration

System ①

User Mgr.

2 Antenna Information

| | |
|-----------------------|-----------------|
| Antenna Size | xx cm / xx inch |
| Antenna Voltage | 44.8V |
| ACU Voltage | 28.0V |
| | |
| Antenna Product | xx-xx-xxxx |
| ACU Product | xx-xxxxx |
| Antenna Serial Number | xxxxxxxxxxxx |
| ACU Serial Number | xxxxxxxxxxxx |
| System Polarization | Cross Pol |
| System Band | Ku Band |

3 S/W Version Information

| | |
|------------|-------|
| Controller | v1.00 |
| | |
| ACU Main | v1.00 |
| Lib Ver | v1.00 |

4 Network Information

| | |
|----------------------|-------------|
| Control IP | 192.168.2.1 |
| Current IP | 192.168.2.1 |
| Idle Session Timeout | xx:xx:xx |
| Date | xxxx-xx-xx |
| Time | xx:xx:xx |

| No. | Item | Description |
|-----|-------------------------|---|
| ① | System | Displays system information such as the antenna, S/W version, and network IP address. |
| ② | Antenna Information | Displays antenna information. |
| ③ | S/W Version Information | Displays S/W version information. |
| ④ | Network Information | Displays network information. |

9.5.4 User Manager

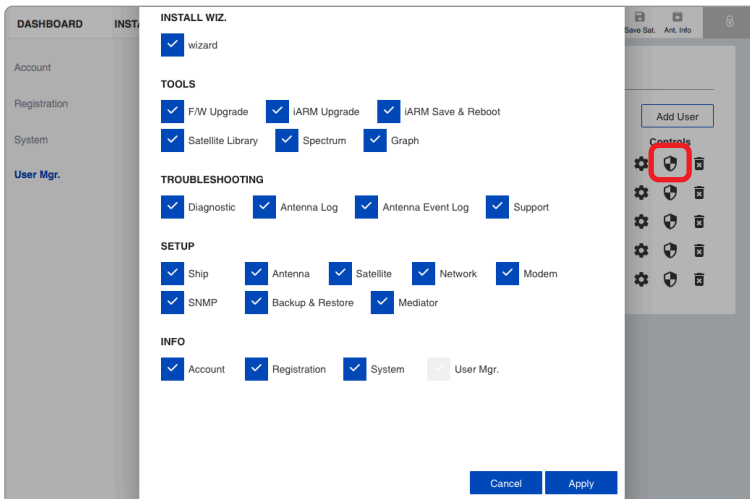
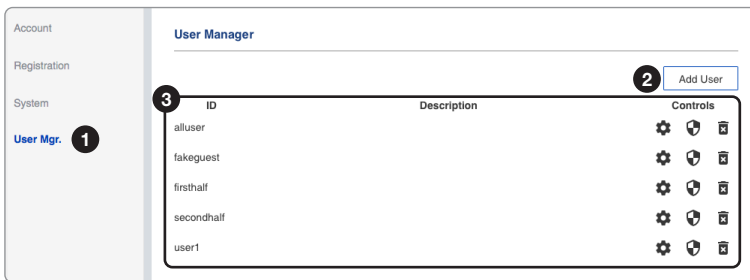

Editable User Permissions Menu

| No. | Item | Description |
|-----|----------------------|---|
| ① | User Manager | The captain with admin permissions can control and manage user permissions separately. |
| ② | Add User | To create a new user, click the Add User button. Then the pop-up window is opened. Enter the new user ID and password, then click the Add User . |
| ③ | User Management List | <p>Displays the user management state and can control and manage through the control buttons.</p> <ul style="list-style-type: none"> • ID: displays the registered user ID. • Description: Displays the user's description. • Controls: Each user can be controlled and managed by individual settings. <ul style="list-style-type: none"> - User Setting: Reset the user ID by clicking the Update User button, and changes the password by clicking the Reset Password button. - Edit Menu Permission: Choose user permissions to give by selecting the checkboxes, then click the Apply button. The user can access only the permitted options. - Delete User: Deletes the user. |

9.6 Dashboard

The Dashboard menu is displayed as below to provide quick monitoring of the antenna status. The Dashboard helps you arrange panels on a single screen while providing you with a broad view of a variety of information at once. The dashboard contains multiple panels, which can easily customize the structure of your dashboard and arrange your panels in various ways to make them more readable and user-friendly.

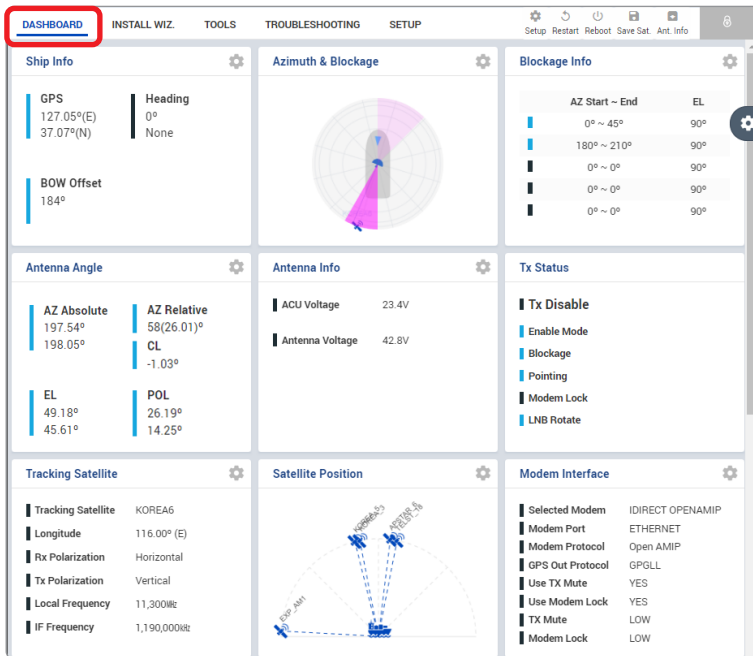

9.6.1 How to Add & Remove Panels (Dashboard Setting)

Adding Panels

1. On the right side of the page, you will see the gear icon to edit your dashboard. To start editing, click on the gear icon.
2. Check the box of the panel that you wish to add to the dashboard.
3. Click the **Apply** button to apply the settings to the system.
4. Once the panel is added, it will be automatically placed at the bottom of the page.

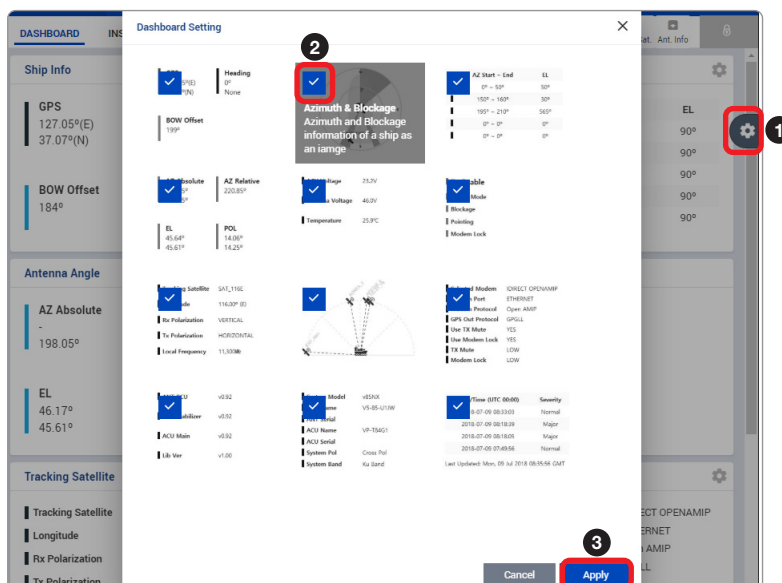

Removing Panels

1. On the right side of the page, you will see the gear icon to edit your dashboard. To start editing, click on the gear icon indicated by the red mark.
2. Uncheck the box of the panel that you wish to remove from the dashboard.
3. Click the **Apply** button to apply the settings to the system.

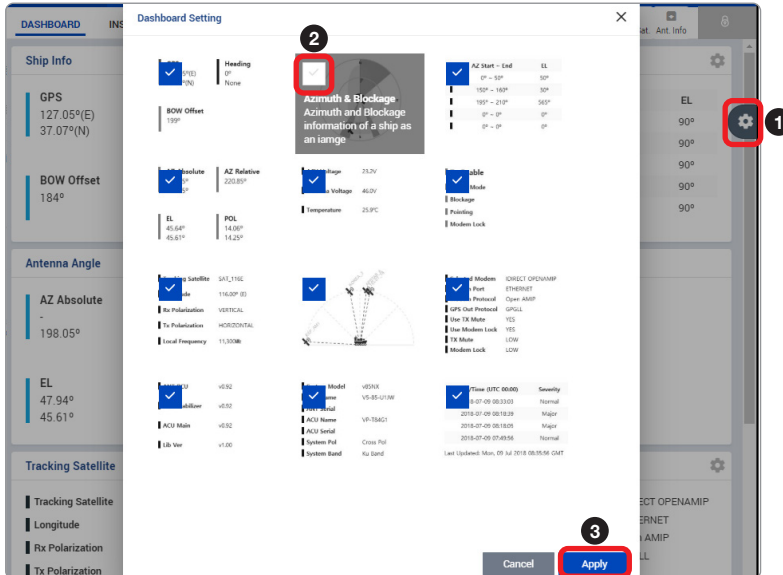

9.6.2 How to Arrange Dashboard Layout

You can customize the dashboard by rearranging panels as you wish.

1. Click and hold the left mouse button on a panel's title and then drag-and-drop in the desired position.

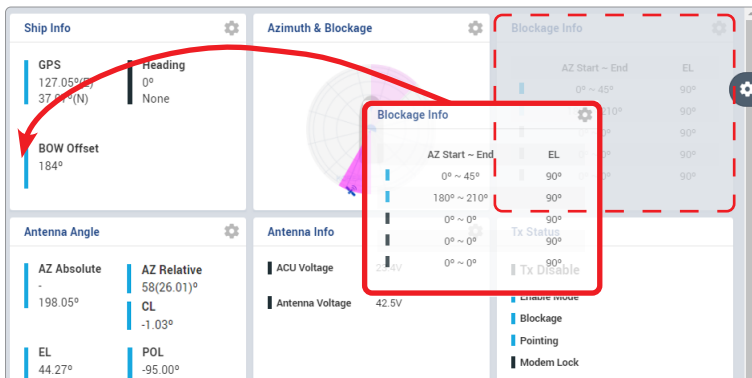

2. This time, the selected panel will be moved to the desired position. You can also move multiple panels into a customized layout in the same manner.

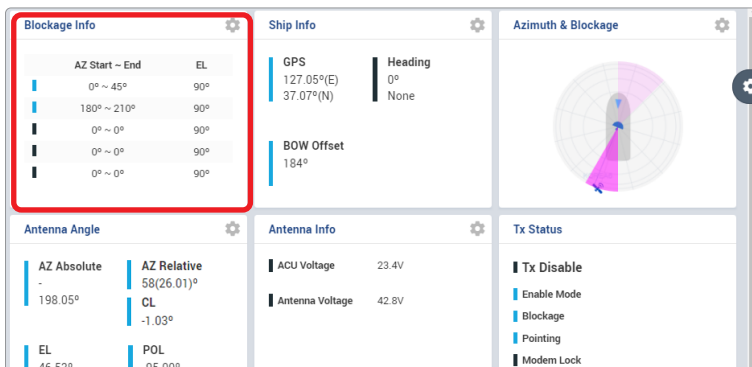

9.6.3 How to Use Shortcut Settings

Each panel on the dashboard provides a shortcut function. Using the **Shortcut** button on right side of the panel, you can easily access the detailed information and manage the each panel's settings.

1. Click the **Shortcut** button indicated by the red mark to open the setting page.

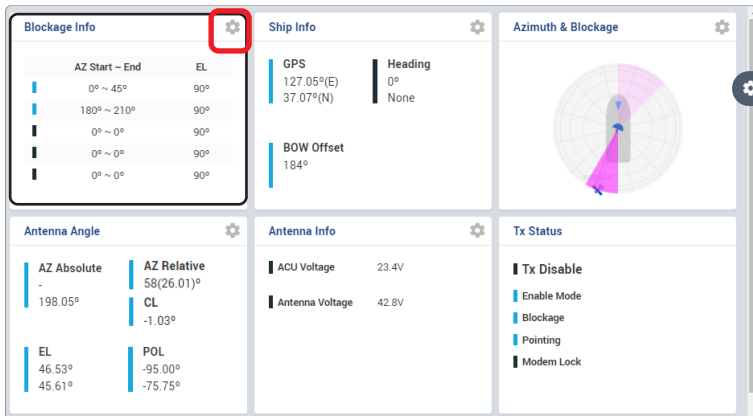

2. The setting page will appear on the individualized web page. You can check the detailed information and quickly apply settings that you wish.

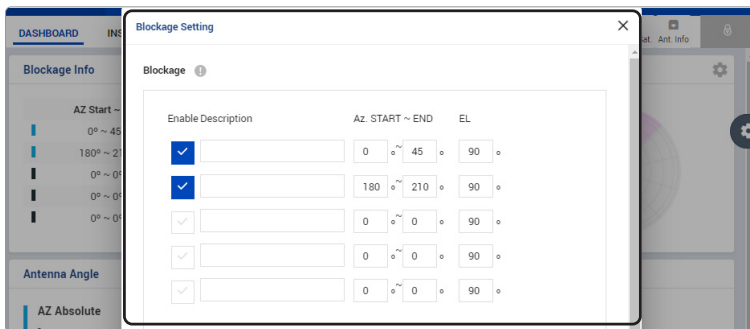

9.7 Install Wizard

The description of this menu is written on the previous page. Refer to the "6.4 Starting Install Wizard" on page 44 for more details.

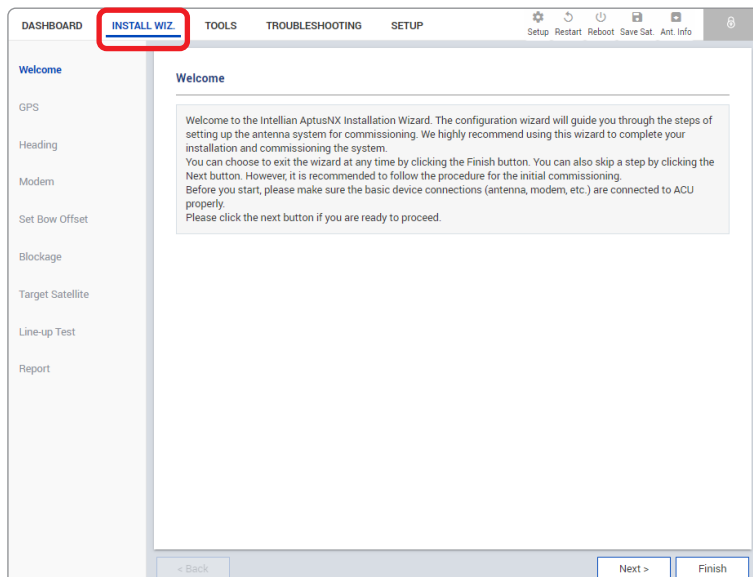

9.8 System Tools

This menu sets and displays the F/W Upgrade, iARM Upgrade, iARM Save&Reboot, Satellite Library, and Graph function.

9.8.1 Firmware Upgrade

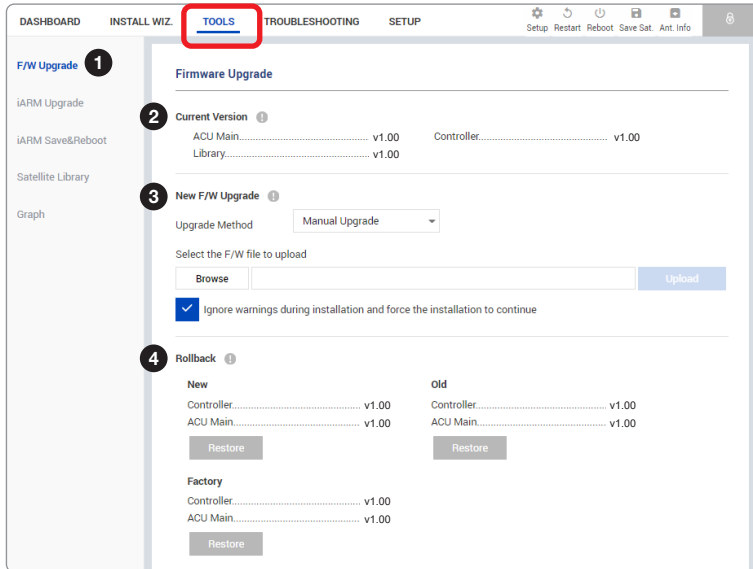

| No. | Item | Description |
|-----|------------------|---|
| ① | Firmware Upgrade | Displays current firmware versions and upgrades antenna firmware. |
| ② | Current Version | Displays current firmware versions. |
| ③ | New F/W Upgrade | <p>Upgrades antenna firmware. The update may take a few minutes to complete. The upload time may vary due to a variety of factors such as the speeds of your network. Uploading an incorrect firmware file may cause serious damage to your antenna and ACU. Check firmware version before uploading firmware.</p> <ul style="list-style-type: none"> Upgrade Method: selects an upgrade method between Manual Upgrade or Auto Upgrade. <p>NOTE: When using the Manual Upgrade method, refer to the following "Antenna Firmware Update (Manual Upgrade method) Procedures" page for more details.</p> |
| ④ | Rollback | <p>Displays the previous and latest versions of the firmware package and restores them. Other function cannot be operated while rollback is in process.</p> <ul style="list-style-type: none"> New: Most currently upgraded version of firmware Old: Previous version of firmware before the upgrade Factory: Initial version of firmware which was installed by the factory <p>The new, old or factory version of firmware can be restored by clicking on the RESTORE button.</p> |

Antenna Firmware Upgrade (Manual Upgrade method) Procedures:

1. Choose **Manual Upgrade** from the pull-down menu of Upgrade Method. Browse and select the upgrade package file to upload. Click on the **Upload** button to transfer the Firmware package file (*.fwp) to iARM module.



NOTE

If you select the box "Ignore warnings during installation and force the installation to continue", warning messages do not appear during the upgrade.

2. The antenna firmware versions are displayed on the pop-up window. Check the current version installed and the new version available for each type of firmware, then click the **Start Upgrade** button.

| Type | Current Ver. | New Ver. |
|------------|--------------|----------|
| Controller | v1.00 | v1.01 |
| ACU Main | v1.00 | v1.01 |

3. The upgrade of each firmware type is performed in order, and the process is displayed on the window. If the current version matches with the new version of the firmware, the upgrade process is skipped.

| Type | Current Ver. | New Ver. | Result |
|------------|--------------|----------|--------|
| Controller | v1.00 | v1.01 | 25 % |
| ACU Main | v1.00 | v1.01 | Ready |

4. If the firmware is successfully upgraded, the result is marked as "Success". Click the **Ok** button to close the pop-up window.

| Type | Current Ver. | New Ver. | Result |
|------------|--------------|----------|---------|
| Controller | v1.00 | v1.01 | Success |
| ACU Main | v1.00 | v1.01 | Success |

9.8.2 iARM Upgrade

The screenshot shows the 'iARM Upgrade' configuration page. It is divided into four numbered sections:

- 1 iARM Upgrade:** A sidebar menu item.
- 2 New iARM Firmware:** A section with a 'Browse' button to select a file and a 'Start Upgrade' button. Below it is a checkbox labeled 'Ignore warnings during installation and force the installation to continue.' which is checked.
- 3 Bootstrap/Bootloader:** A table showing versions for Bootstrap and Bootloader.

| Component | Option | Version |
|------------|-------------------|---------|
| Bootstrap | Main | v1.00 |
| | Factory Default | v1.00 |
| Bootloader | Main | v1.00 |
| | Factory Default | v1.00 |
| | Active Bootloader | Main |
- 4 Kernel/File System:** A table showing versions for Sys0, Sys1, and Factory Default.

| Storage Part | Component | Version | Action |
|-----------------|-----------------|---------|-----------|
| Sys0 | Kernel | v1.00 | Activate |
| | File System | v1.00 | |
| Sys1 | Kernel | v1.00 | Activated |
| | File System | v1.00 | |
| Factory Default | Kernel | v1.00 | Activate |
| | File System | v1.00 | |
| Current Active | Current Package | .Sys1 | |
| | Kernel | v1.00 | |
| | File System | v1.00 | |

| No. | Item | Description |
|-----|----------------------|---|
| ① | iARM Upgrade | Upgrades the firmware of iARM module. |
| ② | New iARM Firmware | <p>Browse and select the iARM firmware file to upload and click Start Upload button. The update may take a few minutes to complete. The upload time may vary due to a variety of factors such as the speeds of your network. Uploading an incorrect firmware file may cause serious damage to your antenna and ACU. Check the firmware version before uploading firmware.</p> <p>NOTE: refer to the following "iARM Upgrade Procedures" page for more details.</p> |
| ③ | Bootstrap/Bootloader | <p>Displays current bootstrap and bootloader version.</p> <ul style="list-style-type: none"> • Bootstrap: displays the Bootstrap Version (Main, Factory Default). • Bootloader: displays the Bootloader Version (Main, Factory Default, Active Bootloader) |
| ④ | Kernel/File System | <p>The ACU has three storage parts the Sys0, the Sys1 and the Factory Default. Selects the desired storage part and click the Activate button. Then perform the "8.8.3 iARM Save & Reboot" on page 69 to apply the settings to the system.</p> <ul style="list-style-type: none"> • Sys0: displays the Sys0 version. • Sys1: displays the Sys1 version. • Factory Default: displays the Factory Default version. <p>The Current Active displays activated storage part Information.</p> <ul style="list-style-type: none"> • Current Active <ul style="list-style-type: none"> - Current Package: displays the activated storage part's name (Sys0, Sys1 or Factory Default). - Kernel, File System: displays the activated storage part's file version. |

iARM Upgrade Procedures:

1. Browse and select the iARM firmware file (.tgz) that you wish to upgrade. Click on **Start Update** button to update the iARM firmware. Wait until the page is loaded.

New iARM Firmware ⓘ

1 Select the FW file to upload

Browse

2 Start Upgrade

Ignore warnings during installation and force the installation to continue.



NOTE

If you select the box "Ignore warnings during installation and force the installation to continue", warning messages do not appear during the upgrade.

2. Once the update starts, the update process will be displayed on the screen. It will take about two minutes to complete the firmware upgrade.



WARNING

Do not turn off the device power if the firmware upgrade page is displayed. Failure to comply may lead to damage and/or malfunction of the system.

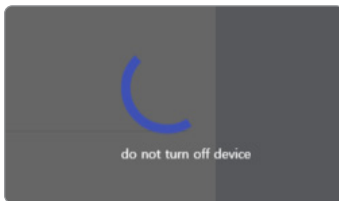

3. Once the upgrade is completed, the iARM module will automatically reboot in 10 seconds.

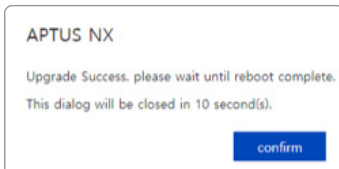

9.8.3 iARM Save & Reboot

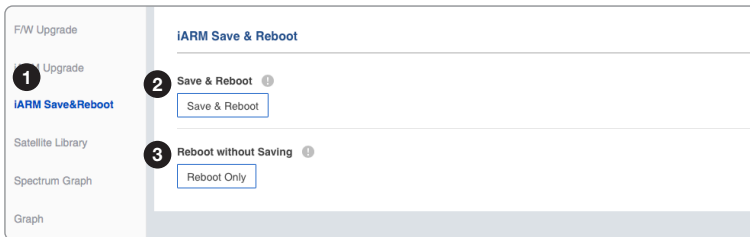

| No. | Item | Description |
|-----|-----------------------|---|
| ① | iARM Save & Reboot | Save settings for the iARM and reboot the system. |
| ② | Save & Reboot | Saves the modified settings for the iARM, and reboots the system. All configuration changes made will be saved in the ACU and effective upon the reboot. Click the Save & Reboot button. |
| ③ | Reboot without Saving | Reboots the system without saving the modified settings of the iARM . All configuration changes made will be lost upon the reboot. Click the Reboot Only button. |

9.8.4 Satellite Library

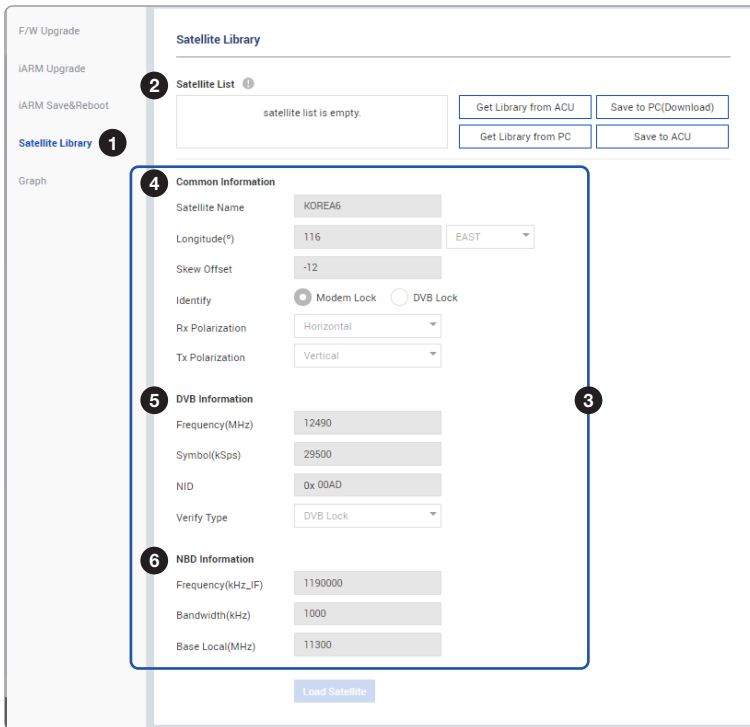

| No. | Item | Description |
|-----|-----------------------|---|
| ① | Satellite Library | Sets the satellite library information. |
| ② | Satellite List | Reads or manages satellite information from the library. <ul style="list-style-type: none"> • Get Library from ACU: obtains satellite library file from the ACU. • Get Library from PC: obtains the satellite library file from the PC. • Save to PC (Download): saves the current library file to the PC. • Save to ACU: saves the current library file to the ACU. |
| ③ | Satellite Information | Select one of the satellites in the Satellite List then Click the Load Satellite button to load the satellite information. |
| ④ | Common Information | Displays selected satellite information. <ul style="list-style-type: none"> • Satellite Name: displays the satellite name. • Longitude(°): displays satellite orbit position. • Skew Offset: displays the Skew offset. • Identify: displays the lock setting type (Modem Lock / DVB Lock) for satellite tracking. • Rx Polarization: displays the current Rx polarization. • Tx Polarization: displays the current Tx polarization. |
| ⑤ | DVB Information | Displays DVB mode's tracking information. <ul style="list-style-type: none"> • Frequency (MHz): displays the tracking frequency. • Symbol (kSps): displays the symbol rate. • NID: displays the network ID. • Verify Type: displays the verification type. |
| ⑥ | NBD Information | Displays NBD mode's tracking information. <ul style="list-style-type: none"> • Frequency (kHz_IF): sets the tracking frequency. • Bandwidth (kHz): sets the detection bandwidth. • Base Local (MHz): sets the base local. |

9.8.5 Graph

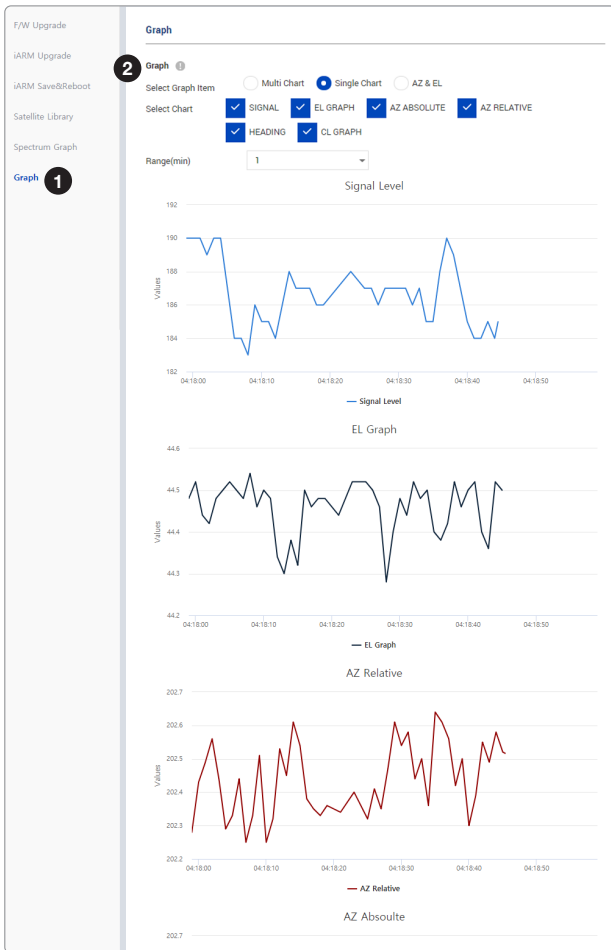

Single Chart View

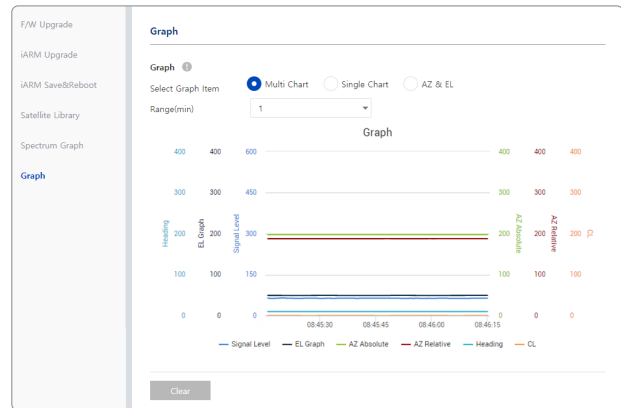

Multi Chart View

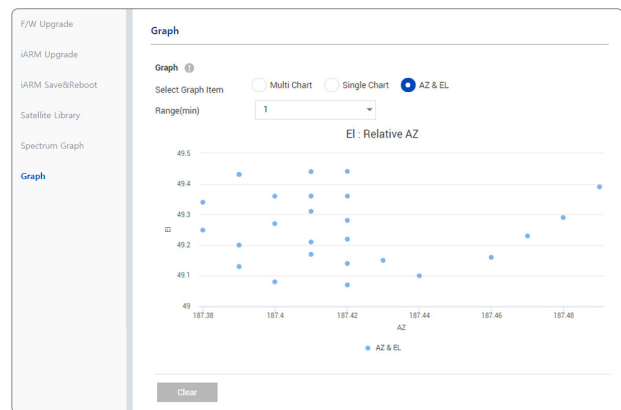

AZ & EL View

| No. | Item | Description |
|-----|-------|---|
| ① | Graph | This view provides information on the Signal Level, EL Graph, AZ Absolute, AZ Relative, Heading, and CL Graph in the Multi Chart, Single Chart or AZ & EL formats. |
| ② | Graph | Sets detailed options for the graph. <ul style="list-style-type: none"> Select Graph Item: shows the graphs of only the checked item(s) in the Multi Chart, Single Chart or AZ & EL formats. Multi Chart: displays multiple graph Items in one graph View. Single Chart: displays the checked graph Item in each graph View. AZ & EL: displays the AZ / EL angle value in one graph View. Range(min): displays the data for the set time. By clicking the Clear button, the existing displayed graph is cleared and a new graph is displayed. |

9.9 System Troubleshooting

This menu sets and displays the Diagnosis, Antenna Log, Antenna Event Log and Support function.

9.9.1 Diagnosis

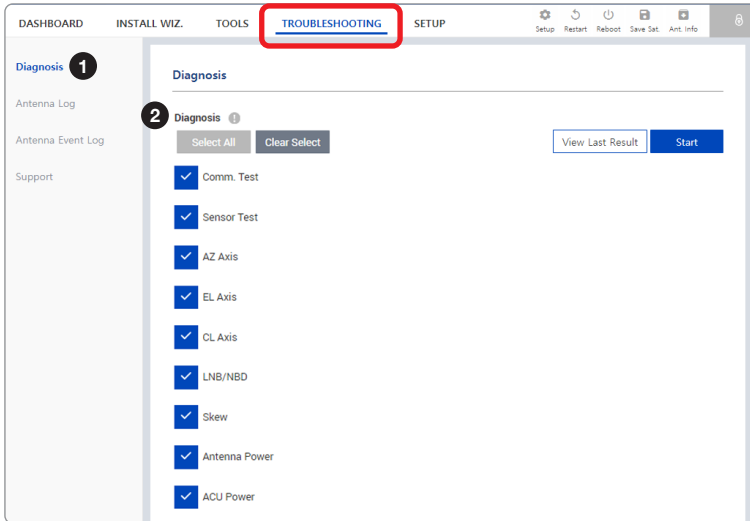

| No. | Item | Description |
|-----|-----------|---|
| ① | Diagnosis | Executes antenna diagnosis test to check the antenna status. |
| ② | Diagnosis | <p>Select the checkbox (full diagnosis test or single diagnosis test) before modifying the settings.</p> <ul style="list-style-type: none"> • Select All: select to run a full diagnosis test. • Clear Select: select to run a single diagnosis test. • View Last Result: displays the recently saved diagnosis result. • Start: executes the diagnosis test. |

Diagnosis Procedures:

1. Select the checkbox (full diagnosis test or single diagnosis test) before modifying the settings. Click on the **Start** button to run the diagnostic test.

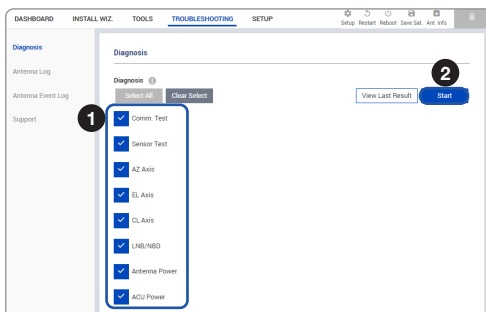

- Once the diagnosis starts, the page will indicate test status. It should take a few minutes to complete the test.

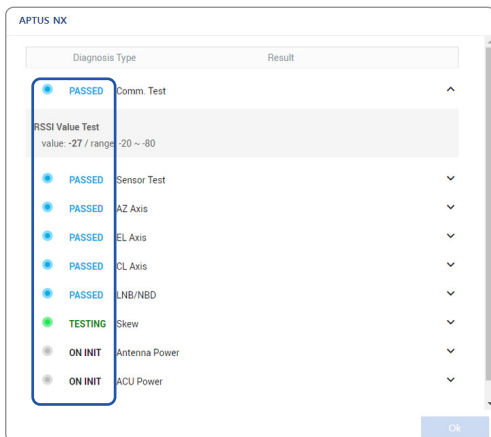

- After the diagnosis is completed the system shows the diagnosis results of each item. You can save the results to the ACU by clicking the **Save Report** button and print this page by clicking the **Print** button. To remove the result, click the **Clear Diagnosis** button.

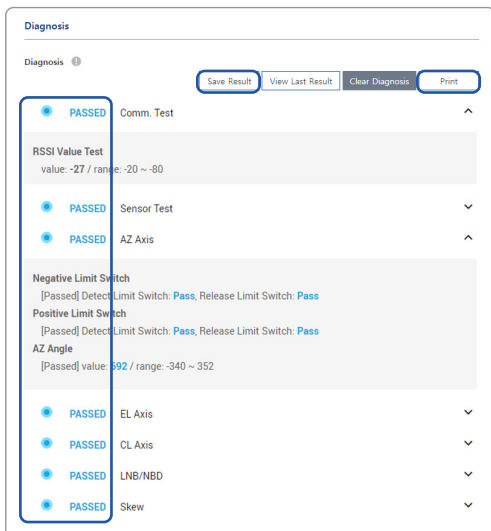

- When you want to check the recently saved diagnosis results, click the **View Last Report** button. The pop-up page of the diagnosis results, including the save date and time, will appear. You can print this page by clicking the **Print** button.

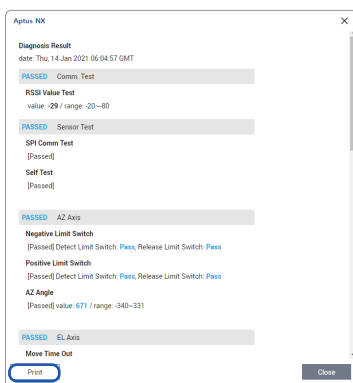
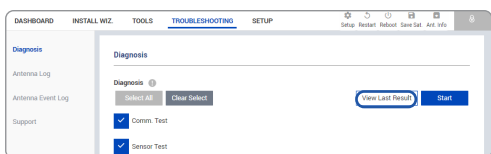

9.9.2 Antenna Log

Diagnosis

Antenna Log ①

Antenna Event Log

Support

2 GPS Log Option ②

Turn On Off On

3 Antenna Log Download ③

Duration

Include Backup/Report File Compress

[Start Download](#)

4 Antenna F/W Log ④

| Date/Time (UTC 00:00) | Controller | Main |
|---------------------------|-----------------|-----------------|
| Tue, 29 Oct 2019 23:37:28 | 1.05 Success | 1.15 Success |

| No. | Item | Description |
|-----|----------------------|--|
| ① | Antenna Log | Displays the antenna log data. |
| ② | GPS Log Option | Turns on/off the GPS log download option. Click the Apply button to apply the settings to the system. |
| ③ | Antenna Log Download | Any log data within three months can be downloaded. Select the duration on the calendar view that you want to show. Then click the Start Download button. NOTE: when selecting the box Include Backup/Report File before downloading, the Backup/Report File will download together. When selecting the box Compress before downloading, log files are downloaded in a compressed format. |
| ④ | Antenna F/W Log | Displays log information about firmware upgrade. |

9.9.3 Antenna Event Log

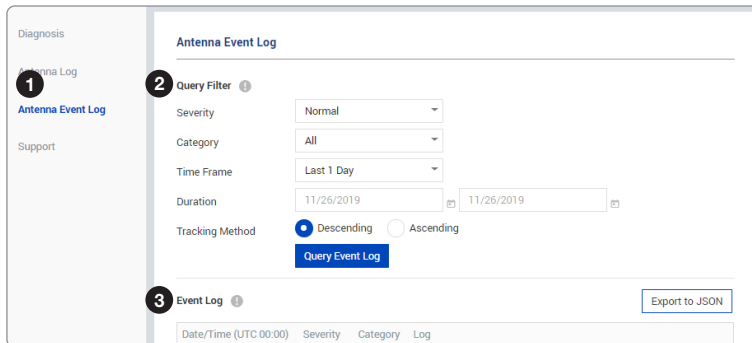

| No. | Item | Description |
|-----|-------------------|---|
| ① | Antenna Event Log | Displays the antenna system and user log information by setting urgency level. |
| ② | Query Filter | <p>Sets the log message option to display the event log.</p> <ul style="list-style-type: none"> Severity: sets the urgency level. Category: sets the target that caused the message. Time Frame: sets the time limit that you want to show. Duration: sets the duration on the calendar view that you want to show. Tracking Method: sets the sorting type (Descending / Ascending). <p>Click the Query Event Log button to apply the settings to the system.</p> |
| ③ | Event Log | Displays event log information. |

9.9.4 Support

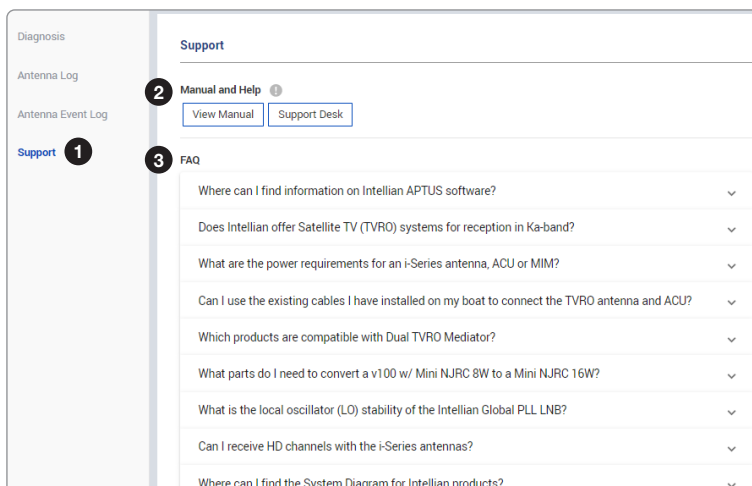

| No. | Item | Description |
|-----|-----------------|---|
| ① | Support | Supports the manual web page, support desk and FAQ list. |
| ② | Manual and Help | <p>Shows the manual web page and support desk information.</p> <ul style="list-style-type: none"> View Manual: click the View Manual button to open the manual web page. Support Desk: click the Support Desk button to open Intellian's contact details for support. |
| ③ | FAQ | Provides answers to frequently asked questions about the product. |

9.10 System Setting

This menu sets and displays the Ship, Antenna, Satellite, Network, Modem, SNMP, and Backup & Restore function.

9.10.1 Ship Setting

The screenshot shows the 'SHIP' configuration page. The 'SETUP' tab is highlighted in red. The page is divided into sections: 1. Ship (selected), 2. GPS (Longitude: 127.05, Latitude: 37.07), 3. Heading Device (Current Device: NMEA, Baud Rate: 4800), 4. BOW Offset (Current Bow Offset: 184), and 5. Blockage (a table with columns for Enable, Description, Az. START, END, and EL). A red dashed box highlights the BOW Offset section, with a red arrow pointing to it from the word 'NOTE'.



NOTE

This function must be used by experienced engineers only.

| No. | Item | Description |
|-----|------|---|
| ① | Ship | Sets the ship information and block zone. |

| No. | Item | Description |
|-----|----------------|---|
| ② | GPS | <p>Sets the GPS position of the vessel for searching for a satellite. Check the GPS status connected to the antenna system. The indicator left of the help button shows the GPS status. Make sure the GPS indicator is Blue (blinking). (Blue (blinking): the system received a correct GPS input. Black: the system has not received a GPS input. You can enter the GPS value manually to set the GPS position.)</p> <ul style="list-style-type: none"> • Longitude(°): sets Longitude information (East / West). • Latitude(°): sets Latitude information (North / South). <p>Click the Apply button to apply the settings to the system.</p> |
| ③ | Heading Device | <p>Sets the ship's heading device. Choose the device type from the Current Device drop-down list. The indicator left of the help button shows the device connection status. (Blue: a ship's heading device is connected. Black: a ship's heading device is not connected.)</p> <ul style="list-style-type: none"> • Current Device: select the heading device (None, NMEA (0183), Static). • Baud Rate: select the band rate (4800, 9600, 19200, 38400). It must be set when NMEA is selected on the Current Device list. • Heading(°): enter the heading information. <p>Click the Apply button to apply the settings to the system.</p> |
| ④ | BOW Offset | <p><i>This function must be used by experienced engineers only.</i></p> <p>For setting bow offset, you need to select a satellite which is trackable in satellite library information.</p> <ul style="list-style-type: none"> • Current Bow Offset (°): Displays the Bow Offset Range (0 – 360°). <p>Click the Apply button to apply the settings to the system.</p> |
| ⑤ | Blockage | <p>It is important to set up the blockage zones for Intellian VSAT. The VSAT system can be programmed with relative azimuth and elevation sectors to create up to five zones for transmission mute.</p> <p>It is indicated when the antenna is within one of the zones. A transmit inhibit output from the ACU will disable/mute the modem transmission within the blockage zones.</p> <p>The AZ START is the relative azimuth angle where the blockage starts, and the AZ END is the relative azimuth where the blockage ends (Range: 0 ~ 360).</p> <p>The EL is the elevation angle where the blockage is set (Range: 0 ~ 90). The blockage is activated below the elevation angle.</p> <p>Click the Apply button to apply the settings to the system.</p> |

9.10.2 Antenna Setting



NOTE

This function must be used by experienced engineers only.

| No. | Item | Description |
|-----|-----------------|--|
| ① | Antenna Setting | Sets current antenna position and search parameters. These parameters should only be changed by an authorized service technician. Improper setting of these parameters will render your system inoperable. |
| ② | Antenna Angle | Enter Setup Mode to modify settings. Sets current antenna position and LNB pol angle. You can move the antenna's azimuth, elevation, and cross level position and LNB pol angle by using the arrows or inputting a value to find the desired satellite manually. <ul style="list-style-type: none"> Relative Azimuth: Displays the antenna relative azimuth angle. Absolute Azimuth: sets the antenna absolute azimuth angle. Elevation: sets the elevation angle. LNB Pol Angle: sets the LNB pol angle. Cross Level: sets the cross level angle. Click the Set to zero button to set a zero angle automatically. |

| No. | Item | Description |
|-----|-----------------------------------|---|
| ③ | Thresholds Setting | Sets current detect level threshold and tracking level threshold. <ul style="list-style-type: none"> • Detect Level: sets the current detect level threshold. • Tracking Level: sets the current tracking level threshold. • Tx Enable: sets the Tx enable threshold. Click the Apply button to apply the settings to the system. |
| ④ | Search Parameter | Sets the time-out. <ul style="list-style-type: none"> • Wait Time (sec): sets the time-out for automatic initiation of a search after the signal level drops below the pre-defined threshold value. Click the Apply button to apply the settings to the system. |
| ⑤ | Conical Range | Sets the conical range. The conical range is the relative force of the motors controlling azimuth and elevation. Click the Apply button to apply the settings to the system. |
| ⑥ | Rate Sensor Bias | <p><i>This function must be used by experienced engineers only.</i></p> The rate values of the azimuth, elevation, and cross-level axes were calibrated to the optimal condition at the factory prior to shipment. An additional rate adjustment is not required. If replacing the sensor part, the rate sensor calibration should be performed by experienced engineers. |
| ⑦ | LNB Pol Sensor Calibration (Skew) | Calibrates the LNB pol angle when the control board, the skew motor or belt is replaced. <ul style="list-style-type: none"> • Sat Skew Offset: Displays the skew offset value. • Mechanical Offset: Displays the skew offset value. The indicator right of the value box shows the skew offset status. <ul style="list-style-type: none"> - Blue: Mechanical skew offset value is less than ± 10 degrees. - Red: Mechanical skew offset value is greater than ± 10 degrees. • Consolidated Offset: Displays the consolidated offset value. • Pol Sensor Calibration: Calibrates the skew motor and checks the skew range. • Mechanical Skew Offset Reset: To reset the mechanical skew offset value to 0, click on the Mechanical Skew Offset Reset button. The mechanical skew offset is pre-set with a factory default value (0, 1 or 2) depending on the assembly condition. You may need to reset the mechanical skew offset when the satellite skew offset is unknown (consolidated skew offset = satellite skew offset + mechanical skew offset). Mechanical skew offset is set automatically by moving the Pol Angle left or right in the search or tracking mode. <p>NOTE: Each satellite has its own skew offset. Intellian recommends you to contact your service provider or satellite operator to get the satellite skew offset value. To set the satellite offset value, go to SETUP menu → Satellite → Satellite Information → Skew Offset.</p> |
| ⑧ | Antenna Mode | Sets the motor to idle mode to check the antenna's balance. <ul style="list-style-type: none"> • Set Idle Mode: Enter Setup Mode to modify settings. Releases the elevation and cross-level motor. • Reboot: Reboots the system. |

9.10.3 Tracking Satellite Setting

| No. | Item | Description |
|-----|---------------------------------|--|
| ① | Tracking Satellite Setting | Sets the current tracking satellite settings. |
| ② | Satellite Information | <p>Sets the current tracking satellite settings.</p> <ul style="list-style-type: none"> • Satellite Name: sets the satellite name. • Longitude(°): sets the satellite orbit position. • Skew Offset(°): sets the skew offset. • Local Frequency (MHz): sets the local frequency. • Rx Polarization: sets the current Rx polarization. • Tx Polarization: displays the current Tx polarization. • Identify: sets the lock setting type (Modem Lock / DVB Lock) for satellite tracking. <p>Click the Apply button to apply the settings to the system.</p> |
| ③ | NBD Information | <p>Sets NBD mode's tracking information.</p> <ul style="list-style-type: none"> • Frequency (kHz_IF): sets the tracking frequency. • Reserved Parameter(kHz): sets the reserved parameter. <p>Click the Apply button to apply the settings to the system.</p> |
| ④ | Eutel Satellite | <p>Select ON when the antenna is tracking the Eutelsat satellite. With this option enabled, a defined skew angle for each Eutelsat satellite is automatically applied without allowing a manual modification to the skew offset value.</p> <p>Click the Apply button to apply the settings to the system.</p> |
| ⑤ | Modem Lock Use for Verification | <p>Verifies modem lock status (modem lock function: active/inactive).</p> <ul style="list-style-type: none"> • Modem Verify: choose whether to use the modem lock function or not. (On / Off) <p>Click the Apply button to apply the settings to the system.</p> |

9.10.4 Network Configuration

This function is available after performing the "8.8.3 iARM Save & Reboot" on page 69.

The screenshot shows the 'Network Configuration' page with the following sections:

- 1 Network Configuration:** A sidebar menu with 'Network' selected.
- 2 Management Interface Configuration:** Fields for IP Address (192.168.2.1), Subnet Mask (255.255.255.0), Lease Start Address (192.168.2.2), Lease End Address (192.168.2.30), and Lease Time (min) (180).
- 3 Network Service Configuration:** Radio buttons for Telnet Service (Disable selected), HTTP Port (443), and SSH Service (Enable selected).
- 4 Sys Log Configuration:** Radio buttons for Management Server (No selected), Server IP (192.168.1.1), UDP Port (514), and Message Type (Error, Major, Minor, Diagnosis, Periodic, Special, Setting, Notice).
- 5 Radius Configuration:** Radio buttons for Client (Disable selected), Server IP (192.168.1.10), Timeout (5), and Server Secret (testing123).

APTUS NX

All configuration changes made will be saved in the ACU and effective upon reboot.

Automatically Save&Reboot upon apply.

NOTE



When clicking the **Apply** button after editing the system settings, this pop-up message will appear. If you want to automatically save and reboot the system, select the checkbox and click the **Confirm** button.

| No. | Item | Description |
|-----|------------------------------------|--|
| ① | Network Configuration | Sets the ACU's Internal IP address and ports. |
| ② | Management Interface Configuration | <p>Sets the Management Port's network configuration. The Management Port is located on the ACU front panel.</p> <ul style="list-style-type: none"> • IP Address: sets the network IP address (Factory default: 192.168.2.1). • Subnet Mask: sets the subnet mask (Factory default: 255.255.255.0). • Lease Start Address: sets the lease IP address start range. • Lease End Address: sets the lease IP address end range. • Lease Time: sets the lease IP address update time. <p>Click the Apply button to apply the settings to the system.</p> |

| No. | Item | Description |
|-----|-------------------------------|---|
| ③ | Network Service Configuration | <p>Sets the network service configuration</p> <ul style="list-style-type: none"> • Telnet Service: sets the telnet service (Disable / Enable). • HTTPS Port: sets the HTTPS port number. • SSH Service: sets the SSH service status (Disable / Enable). <p>Click the Apply button to apply the settings to the system.</p> |
| ④ | Sys Log Configuration | <p>Sets the system log configuration. Antenna sends log messages according to the emergency level. Enabling this function sends the message to your management server.</p> <ul style="list-style-type: none"> • Management Server: sets the management server status (No / Yes). • Server IP: sets the management server IP address. • UDP Port: sets the management port. • Message Type: selects message type (Intellian message level) to send to the management server (Lower number indicates higher emergency). • Syslog Target Level: if you select this target level, the management server receives a log message equal to or less than this level. <p>Click the Apply button to apply the settings to the system.</p> |
| ⑤ | Radius Configuration | <p>This menu is used when the network administrator needs to authorize user connections using Radius server.</p> <ul style="list-style-type: none"> • Client: sets the Radius authentication (Disable / Enable). • Server IP: sets the Radius server IP Address. • Timeout: sets the Timeout value in seconds for the authentication process. • Server Secret: sets the Pass-Phase. This should be matched between server and ACU. <p>Click the Apply button to apply the settings to the system.</p> |

9.10.5 Modem Setting

Ship

Antenna

Satellite

Network

Modem 1

SNMP

Backup & Restore

2 Modem

Select Modem: IDIRECT OPENAMIP

Modem Port: ETHERNET

Modem Protocol: Open AMIP

GPS Out Sentence: GLL

Use Tx Mute: NO YES

Use Modem Lock: NO YES

Cancel Apply

2 Modem

Select Modem: USER SETTING

Modem Port: RS 232

Modem Protocol: IO Console

GPS Out Sentence: GLL

Use Tx Mute: NO YES

Use Modem Lock: NO YES

Tx Mute: LOW HIGH

Modem Lock: LOW HIGH

Cancel Apply

3 Modem Port Configuration

IP Address (ACU): 10.1.104.225

Subnet Mask: 255.255.255.0

Gateway: 10.1.104.254

MODEM IP: 192.168.1.1

DNS: 168.126.63.1

NAT Routing: Disable Enable

TCP Modem Protocol Port: 4001

UDP Modem Protocol Port: 49184

Cancel Apply

4 Modem Connection

Modem IP: 10.110.6.81

Port: 23

ID: admin

Password:

Auto Connection

Cancel Start

Last Update Date: 2018.10.22 5h:36m:46s

Connect: LOGGEDIN

RX SNR: 14.1

5 Beam Selector

| Beam List | ID | Description |
|-----------|----|--|
| | 85 | ktsat-K8-RMVSAT(not in map) |
| | 81 | ktsat-K5-RMVSAT-Maritime Beam(not in map) |
| | 57 | ktsat-K6-RMVSAT/CMVSAT(not in map) |
| | 27 | ktsat-K5-RMVSAT(not in map) Current |

Apply Lock Reboot Refresh

6 Newtec Modem Monitor

dBm: 0

Es/NO: 0

Ntc_s Request Delay Time (ms): 1000

Cancel Apply

| No. | Item | Description |
|-----|--------------------------|--|
| ① | Modem Setting | Sets parameters for the modem. |
| ② | Modem | <p>Sets the interface between the ACU and the satellite modem.</p> <ul style="list-style-type: none"> • Select Modem: Select your modem type from the Select Modem drop-down list (IDIRECT OPENAMIP, COMTECH ROAM, SATLINK VACP, NEWTEC AMIP) for loading a pre-configuration for the type of modem used. The settings related to the modem interface will be set automatically once the modem type is selected. When you select USER SETTING the other settings can be changed independently. • Modem Port: Select a proper data communication port of the ACU for the satellite modem interface. • Modem Protocol: Select a proper communication protocol of the ACU for the modem interface. • GPS Out Sentence: Select the GPS out sentence type. • Use Tx Mute: Select whether to use the Tx Mute function for the modem or not. • Use Modem Lock: Select whether to use Modem Lock function for the modem or not. • Tx Mute: This function can be edited when User Setting option is selected in the Select Modem menu. It selects the Tx Mute option. The Tx Mute is a transmit inhibit output from the ACU to disable/mute the modem transmit through a 5 V (HIGH) or 0 V (LOW) current whenever the antenna is blocked, searching, or pointed 0.5 degrees off from peak satellite position. • Modem Lock: This function can be edited when User Setting option is selected in the Select Modem menu. It selects the Modem Lock option. The Modem Lock provides a logic input through a 5V (HIGH) or 0 V (LOW) current to the ACU to identify when the system is on the correct satellite. <p>Click the Apply button to apply the settings to the system.</p> |
| ③ | Modem Port Configuration | <p>This function is available after performing the "8.8.3 iARM Save & Reboot" on page 69.</p> <p>Sets the ACU's internal IP address, routing, and ports.</p> <ul style="list-style-type: none"> • IP Address: Enter the network IP address. • Subnet Mask: Enter the subnet mask. • Gateway: Enter the gateway. • MODEM IP: Enter the modem IP. • DNS: Enter the current default DNS address. • NAT Routing: Select the NAT routing (Enable / Disable). • TCP Modem Protocol Port: Enter the TCP port number for modem protocols using TCP as transport. • UDP Modem Protocol Port: Enter the UDP port number for modem protocols using UDP as transport. <p>Click the Apply button to apply the settings to the system.</p> |

| No. | Item | Description |
|-----|----------------------|---|
| ④ | Modem Connection | <p>Enter the connection information of the modem (IDIRECT OPENAMIP, COMTECH ROAM, SATLINK VACP, NEWTEC AMIP).</p> <ul style="list-style-type: none"> • Modem IP: Enter the modem IP address. • Port: Enter the connection port. • ID: Enter the connection ID. • Password: Enter the connection password. • Auto Connect: By enabling the auto connect, the connection information is saved and the modem is connected automatically when the system reboots. • Last Update Date: Displays the last update date and time. • Connect: Displays last updated data and time of the modem data. • Rx SNR: Displays the Rx SNR data. |
| ⑤ | Beam Selector | <p><i>This menu can be edited when IDIRECT Open AMIP Modem option is selected in the Select Modem menu.</i></p> <p>Selects the target satellite that you want to track.</p> <ul style="list-style-type: none"> • Beam List: Choose the target satellite in the list. • Apply: Click the Apply button to apply the selected beam to the system, it will switch to the beam desired. • Lock: Within condition given for test or commissioning, if the user wishes to stay on a selected beam, the user can lock the beam by clicking the Lock button. This will lead modem stays with the user-selected beam. • Reboot: If you do not want to lock the beam, click the Reboot button. • Refresh: Click the Refresh button to load the latest satellite list. |
| ⑥ | Newtec Modem Monitor | <p><i>This menu can be edited when NEWTEC AMIP option is selected in the Select Modem menu.</i></p> <p>Sets the Newtec Modem options.</p> <ul style="list-style-type: none"> • dBm: Displays the signal level from the Newtec Modem. • Es/NO: Displays the Es/NO value from the Newtec Modem. • Ntc_s Request Delay Time (ms): Set the delay time of the system for receiving the signal level (dBm) and Es/NO value from the Newtec Modem. <p>Click the Apply button to apply the settings to the system. Then perform the "8.8.3 iARM Save & Reboot" on page 69.</p> |

9.10.6 SNMP Setting

| No. | Item | Description |
|-----|--------------------------|--|
| ① | SNMP Setting | Sets SNMP configuration. |
| ② | SNMP Agent Configuration | <p>Sets the SNMP configuration.</p> <ul style="list-style-type: none"> SNMP V1/V2 Status: Choose the SNMP mode. V1/V2 Community Name: Enter the SNMP V2 community name. V3 Authentication Type: Enter the SNMP V3 authentication mode. V3 Authentication Encoding: Choose the SNMP V3 authentication encoding. V3 Username: Enter the V3 username of the SNMP Agent. V3 Password: Set the V3 password of the SNMP agent. The password must be at least eight character long. V3 Private Encoding: Choose the SNMP V3 private encoding. V3 Private Password: Set the V3 private password. The password is must be at least eight character long. TRAP IP/Port: Enter the TRAP IP/Port. TRAP Parameter: Enter the SNMP trap specific parameter. <p>Click the Apply button to apply the settings to the system. Then perform the "8.8.3 iARM Save & Reboot" on page 69.</p> |

9.10.7 Backup & Restore

The screenshot shows the 'Backup & Restore' configuration page. On the left is a navigation menu with items: Ship, Antenna, Satellite, Network, Modem, SNMP, and Backup & Restore (highlighted). The main content area is divided into three sections:

- Section 1: Backup & Restore** (indicated by a circled '1' in the left margin). It contains a blue 'Backup' button.
- Section 2: Antenna Backup & Restore** (indicated by a circled '2' in the left margin). It contains:
 - Antenna Backup** (indicated by a circled '1' in the top right): A 'Backup to PC' label and a blue 'Backup' button.
 - Antenna Restore** (indicated by a circled '1' in the top right): A 'Browse' button, an empty text input field, and a blue 'Restore' button.
- Section 3: iARM Backup & Restore** (indicated by a circled '3' in the left margin). It contains:
 - iARM Backup** (indicated by a circled '1' in the top right): Radio buttons for 'Flash' and 'PC' (selected), and a blue 'Backup' button.
 - iARM Restore** (indicated by a circled '1' in the top right): Radio buttons for 'Flash' and 'PC' (selected), a 'Browse' button, an empty text input field, and a blue 'Restore' button.

| No. | Item | Description |
|-----|--------------------------|---|
| ① | Backup & Restore | Backs up & Restores the antenna setting files and the iARM files. |
| ② | Antenna Backup & Restore | <ul style="list-style-type: none"> Antenna Backup: Back up antenna settings and parameters to PC by clicking on the Backup button. Antenna Restore: Restore the antenna setting by uploading the saved backup file from PC. Browse the backup file, then click the Restore button to restore it. |
| ③ | iARM Backup & Restore | <ul style="list-style-type: none"> iARM Backup: Back up iARM setting to internal Flash drive in ACU or PC by clicking the Backup button. iARM Restore: Restore the iARM settings by uploading the saved backup file from internal Flash drive in ACU or PC. Browse the backup file, then click the Restore button to restore it. |

Chapter 10. Specification

10.1 Technical Specification

| Antenna System | | |
|-----------------------------------|--|--|
| Antenna Radome Height | 627 mm (24.68") | |
| Antenna Radome Diameter | Ø610 mm (24.01") | |
| Antenna Reflector Diameter | Ø450 mm (17.71") | |
| Antenna Unit Weight (With Radome) | 23 kg (50.70 lbs) | |
| Platform | Four Axis : Azimuth, Elevation, Cross level, Skew | |
| Positioning | Velocity Control & Position Control using a stepping motor | |
| Pedestal Motion Range | Azimuth Range | 680° |
| | Elevation Range | -5° ~ +115° |
| | Cross-level Range | Up to ±20° |
| Pointing Stabilization Accuracy | 0.2° max in presence of specified ship motions | |
| Ship's motion | Roll | ±15 ° at 6 second |
| | Pitch | ±20° at 6 second |
| | Yaw | ±8° at 6 second |
| | Turning rate | Up to 12°/sec ² & 5°/sec ² |
| AZ/EL/CL/Skew Motor | Stepping Motor | |
| Sensor | IMU Sensor (Triple Gyro & Tri Axis Accelerometer) | |
| Rx | Frequency | 10.7 GHz ~ 12.75 GHz |
| | Gain | Min. 33.2 dBi @ 11.7 GHz (without radome) |
| Tx | Frequency | 13.75 ~ 14.5 GHz |
| | Gain | Min. 34.8 dBi @ 14.25 GHz (without radome) |
| EIRP | Min. 41.5 dBW @ 14.25 GHz (6 W BUC, with radome) | |
| G/T | Min. 12.3 dB/K @ 12.75 GHz (30° EL, with radome) | |
| Cross Pol Isolation | Min. 30 dB | |
| Tx to Rx Isolation | 80 dB @ 13.75 ~ 14.5 GHz | |
| Feed Assembly | Ring focus feed with sub reflector | |
| Polarization | Linear Cross pol only | |
| BUC | NJRC 6W Ku-band BUC (NJT8376UN) | |
| LNB | Universal PLL LNB | |
| ACU to ADU Cable (Antenna Cable) | Single 50 Ω coax RF cable connected from ACU to ADU for Rx, Tx, FSK, Reference and Power | |
| Input power | 48 V DC (max 300 W) through a single RF cable | |

| Antenna Control Unit (ACU) | |
|-----------------------------------|--|
| ACU Size | 431 mm x 350 mm x 44.3 mm |
| ACU Weight | 5.2 Kg |
| LED Indicator | Six LEDs for POWER, INT/SEARCH, TRACKING, LOCK, SETUP/TEST, ERROR |
| Ship's Gyrocompass Interface | NMEA 0183 |
| PC Interface | Front: Ethernet port, USB (PC, DN: Not working) Back: RS-232C (57600 bps 8, N, 1) |
| Modem Interface | Ethernet port, RS-232/422, I/O Console |
| Ethernet port | Front: RJ-45 Management LAN port (1 ea) Back: RJ-45 LAN port (1 ea) |
| RF Port | Antenna: N-Type (1 ea) Modem Tx/Rx: F-Type (2 ea) |
| Input Power | 100 ~ 240 V AC, 50/60 Hz, 1A |

10.2 Environmental Specification

| Test | Intellian Standard | |
|----------------------|--|--|
| Temperature (ADU) | Operational | IEC-60945 (-25°C to +55°C / Power On) |
| | Survival | IEC-60945 (-40°C to +80°C / Powered On and a non-functional state) |
| | Storage | IEC-60945 (-40°C to +85°C / Power off) |
| Temperature (BDU) | Operational | IEC-60945 (-15 °C to +55 °C) |
| | Survival | IEC-60945 (-25 °C to +70 °C) |
| | Storage | IEC-60945 (-40 °C to +85 °C) |
| Humidity (ADU) | IEC-60068-2-30 Upper test Temp: +40°C (-3), Humidity 98 % Lower test Temp.: +15°C (+3), Humidity 71 % ~ 78 % | |
| Water Proofing (ADU) | IEC-60529 (IPX6) | |
| Salt Mist | IEC-60945 Saline solution: 5 ±1 % NaCl Storage period: 7 Days | |

Chapter 11. Warranty

Intellian systems are warrantied against defects in parts and workmanship, these warranties cover TWO (2) YEAR of parts and TWO (2) YEAR of factory repair labor to return the system to its original operational specification. Warranty periods commence from the date of shipment from Intellian facility.

Intellian Technologies warranty does not apply to product that has been damaged and subjected to accident, abuse, misuse, non-authorized modification, incorrect and/or non-authorized service, or to a product on which the serial number has been altered, mutilated or removed. Intellian Technologies, will (at its sole discretion) repair or replace during the warranty period any product which is proven to be defective in materials or workmanship, in accordance with the relevant product warranty policy. All products returned to Intellian Technologies, during the warranty period must be accompanied by a Service Case reference number issued by the dealer/distributor from Intellian Technologies, and (where applicable) a copy of the purchase receipt as a proof of purchase date, prior to shipment. Alternatively, you may bring the product to an authorized Intellian Technologies, dealer/distributor for repair.

Chapter 12. Appendix

12.1 Appendix A. Tightening Torque Specification

This table shows the recommended values of tightening torques.

| Bolt Size | Tightening Torque (N-m) |
|-----------|-------------------------|
| M2 | 0.5 |
| M2.5 | 1 |
| M3 | 1.5 |
| M4 | 3 |
| M5 | 6 |
| M6 | 12 |
| M8 | 27 |
| M10 | 50 |
| M12 | 85 |
| M14 | 130 |
| M16 | 200 |